

**Basic Four[®]
System 200/410
Operator Training Guide**

BFISD 5045D

The information contained herein is proprietary to and considered a trade secret of Management Assistance Inc.

All rights reserved. No part of this publication may be reproduced, recorded or stored in a retrieval system, or transmitted, in any form or by any means, whether electronic, mechanical, photographic, or otherwise, without prior written permission of the Basic Four Information Systems Division of Management Assistance Inc.

All Rights Reserved

BFISD 5045D

Copyright © 1980 by Management Assistance Inc.

Revised 2/81

All specifications are subject to change without notice.

Basic Four and MAI are registered trademarks of Management Assistance Inc.

Printed in the United States of America

Basic Four Information Systems Division/Management Assistance Inc.
14101 Myford Road, Tustin, California 92680/(714) 731-5100

Introduction

Purpose

Beginner or Experienced?

Computer Hardware and Computer Programs

Helping You Learn

Contents

Objectives

Getting Ready

Beginning Your Training

Section 1: System 200/410 Components

Hardware

Basic Components

Video Display Terminal

Central Processing Unit

Magnetic Tape Cartridge Drive Unit

Printer

Software

What Makes It Work? The BOSS

Two Memories

Section 2: Basic Operating Procedures

How The System Works

Turn-On Sequence

Video Display Terminal

Central Processing Unit

Disc Drive

Magnetic Tape Cartridge and Drive Unit

Printer

Summary: Turn-On Sequence

Summary: Turn-Off Sequence

Cautions

VDT

CPU

Tape Unit

Printer

Section 3: Data Processing--Video Display Terminal

VDT Keyboard

Frequently Used Keys

Infrequently Used Keys

Common Typing Errors

Section 4: General Purpose Programs--Utilities

System 200/410 Utilities

Print Directory Listing--*A

Display Disc Directory on VDT--*L

Display File Information on VDT--*F

Section 5: Backup Procedures

Importance of Backup

Terms You Should Know

Two Operating Systems

Beginning Backup Procedure

Communicating With the Computer During Backup

Backup Files

Backing Up Information from Disc to Tape Cartridge

Error Condition

General Error Conditions

Helpful Hints

Section 6: Procedural Errors

Turning On Equipment

Other Errors

Section 7: General Maintenance and Re-Supply

Cleaning Video Display Terminal

Cleaning Central Processing Unit

Cleaning Magnetic Tape Cartridge Drive Unit

Magnetic Head

Motor Capstan

Optional Tape Cleaner

Cleaning Printer

Handling Printer Paper

Loading the Paper

Adjusting Paper to Start at Top of New Page

Reloading Paper During Operation

Adjusting for Forms Thickness and Other Special Situations

Replacing Printer Ribbon

Appendix: System 410 Options

-
- Figure 1. System 200/410
 - Figure 2. Video display terminal
 - Figure 3. Central processing unit
 - Figure 4. Magnetic tape cartridge drive unit
 - Figure 5. Printer
 - Figure 6. System 200/410 components: working relationship
 - Figure 7. VDT front controls
 - Figure 8. Central processing unit
 - Figure 9. CPU control panel
 - Figure 10. CPU operational message
 - Figure 11. Magnetic tape cartridge drive unit
 - Figure 12. Tape cartridge safety lock
 - Figure 13. Tape cartridge drive power switch
 - Figure 14. Inserting tape cartridge
 - Figure 15. Inserting tape cartridge
 - Figure 16. Printer
 - Figure 17. Printer controls
 - Figure 18. Printer head (unit cover open)
 - Figure 19. VDT keyboard
 - Figure 20. Common typing errors
 - Figure 21. Choosing utility program *A
 - Figure 22. Entering disc i.d. to print disc directory
 - Figure 23. Choosing sequence of directory listing: unsorted
 - Figure 24. Directory listing: unsorted
 - Figure 25. Display disc directory, utility *L
 - Figure 26. Choosing sequence of listing: by location
 - Figure 27. Directory listing displayed continuously
 - Figure 28. Display file information, utility *F
 - Figure 29. Identifying file needed
 - Figure 30. File information displayed
 - Figure 31. Backup and restore
 - Figure 32. Two operating systems
 - Figure 33. Backup files: son – father concept
 - Figure 34. Two sets of backup files
 - Figure 35. VDT back controls
 - Figure 36. Removing tape drive unit cover
 - Figure 37. Cleaning head surfaces
 - Figure 38. Cleaning head guides
 - Figure 39. Cleaning motor capstan
 - Figure 40. Replacing tape drive unit cover
 - Figure 41. Paper stacked on printer base
 - Figure 42. Opening printer cover

- Figure 43. Tractor holding paper in place
- Figure 44. Threading paper between rods
- Figure 45. Threading paper under platen
- Figure 46. Placing paper holes on opened tractor
- Figure 47. Tractor covers closed
- Figure 48. Adjusting for paper width
- Figure 49. Paper aligned incorrectly
- Figure 50. Threading paper back over top rack
- Figure 51. Adjusting paper with platen knob
- Figure 52. Adjusting for forms of different thickness
- Figure 53. Printed report stacker
- Figure 54. Lifting new ribbon over lefthand tension arm
- Figure 55. Threading ribbon around roller 2 and slot 3
- Figure 56. Threading ribbon around printer head
- Figure 57. Lifting new ribbon over righthand tension arm
- Figure 58. Printer test pattern

- Table 1. Backup procedures
- Table 2. Disc error
- Table 3. General error conditions
- Table 4. Tape full condition

PURPOSE

The purpose of this training guide is to provide you, the computer operator, with the specialized information and tools you need to become a successful System 200/410 operator. The guide presents a practical self-paced course of instruction designed with two goals in mind --

- KEEPING YOUR INTEREST
- GETTING RESULTS

Beginner or Experienced?

Don't worry if you haven't had any experience using a computer. You should be able to operate the System 200/410 after reading the instructions. If you've had some computer experience, then move through the material at your own pace to learn specifically about the System 200/410.

Computer Hardware and Computer Programs

To use the System 200/410, you must be able to operate both the computer hardware and computer programs.

- Computer hardware consists of the equipment components that make up the computer. This guide tells you how to operate the System 200/410 hardware.
- Computer programs consist of the sets of instructions within the computer that tell it what you want it to do. (These programs are also called software.) A separate guide will be available to explain computer programs.

Helping You Learn

When your System 200/410 arrives, one of our Basic Four Customer Service Representatives should work with you to explain the system. Before the Customer Service Representative comes, you may want to read through this guide.

CONTENTS

In Section 1 you'll read about how the different computer components work and how they relate to each other. In Section 2 you'll learn how to turn each piece of equipment on and off. Section 3 describes in detail how to use the video display terminal, because that is your main link with the computer. Section 4 contains instructions on getting general directory or file information from your computer, just as you would use a card file in a library to learn what information is available. Section 5 discusses backup procedures, which you'll use to safeguard your data files. Section 6 gives some help if you have problems getting the equipment to operate properly. And Section 7 tells you how to clean the equipment and how to load the printer paper and ribbon.

System 410 Users

Operating procedures and instructions for the System 200 and System 410 are almost identical. But some differences do exist. For example, the System 200 user calls the Customer Service Representative for help when needed, whereas the System 410 user calls a Sorbus Service Representative or a programmer. And the System 410 offers more choices in some procedures, which are noted in the text. Otherwise, this manual is planned to serve users of both systems equally well.

OBJECTIVES

After reading the guide, you should be able to:

- Identify the equipment components that make up the System 200/410
- Turn each piece of equipment on and off
- Operate each piece of equipment
- Determine what computer programs and data files are stored in your computer
- Back up your data in case of an emergency
- Respond to common errors that might occur

Getting Ready

To go through this guide, you will need:

- System 200/410
- Box of paper for the printer
- Comfortable location
- Desk or work table
- This Operator's Guide
- Pen or pencil

The preliminary instructions should take approximately 1 hour to study. As you proceed, you'll be referred to the computer to perform certain steps.

Beginning Your Training

Now you're ready to begin. We think you'll find your experience with the System 200/410 surprisingly enjoyable, because use of the computer can make your work much easier. Just remember that the basic steps are simple, though exact, and that the computer will do what you tell it to do. And now--welcome to Basic Four's System 200/410.

HARDWARE

Four of the five basic hardware components (the physical equipment) of the System 200/410 are pictured below (Figure 1).

Basic Components

1. Video display terminal (VDT)
2. Central processing unit (CPU)
3. Disc (not pictured here--located inside the central processing unit)
4. Magnetic tape cartridge drive unit
5. Printer

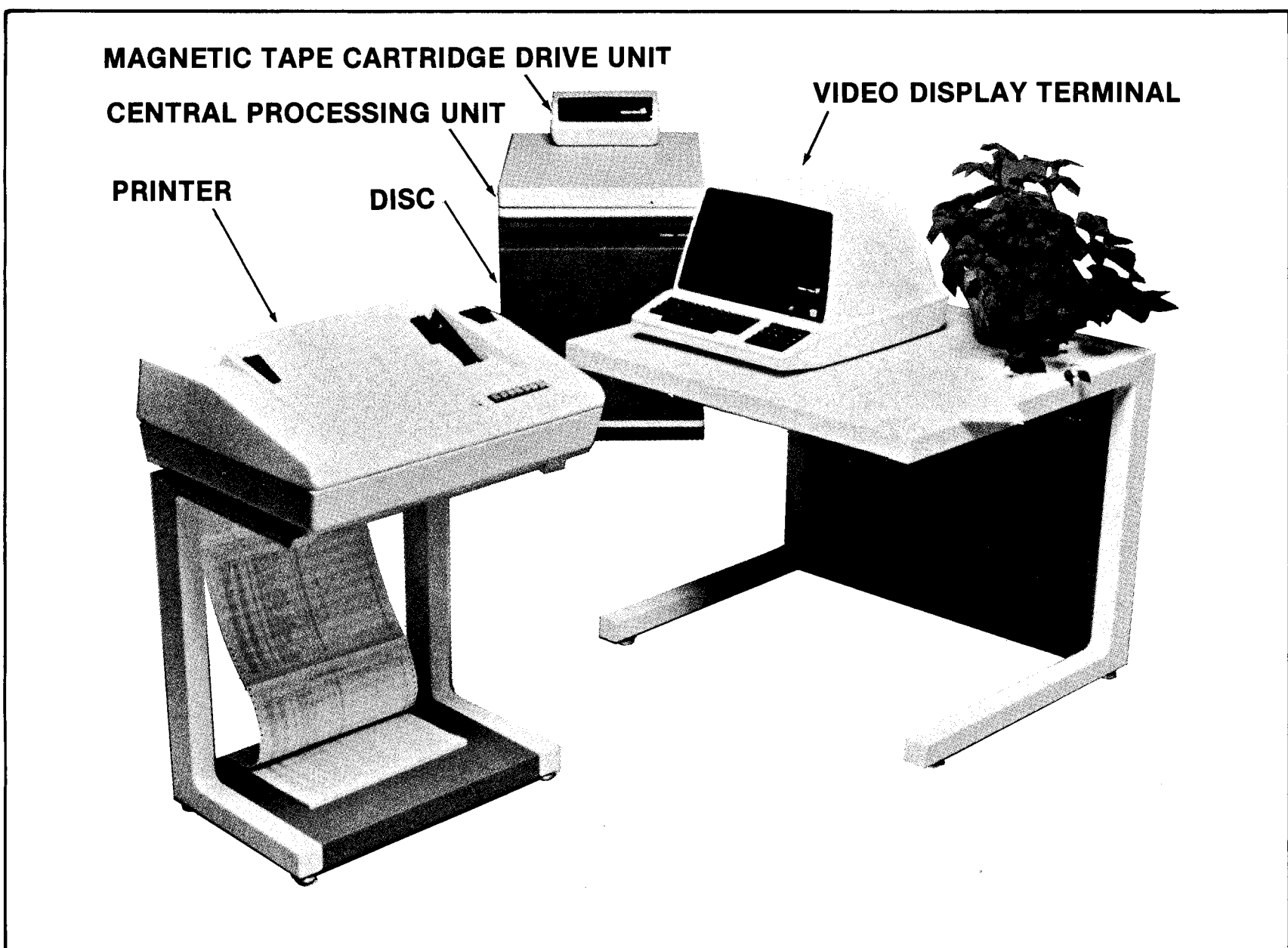

Figure 1. System 200/410

Video Display Terminal

The VDT or video display terminal is your method of communicating with the System 200/410. You'll use the keyboard to enter information which appears on the TV-like screen. The VDT also displays information coming from the computer (Figure 2).



Figure 2. Video display terminal

Central Processing Unit

The Basic Four System 200/410 central processing unit is a compact general purpose computer. It handles all computing for the entire system and is responsible for directing the information between each of the other components (Figure 3).

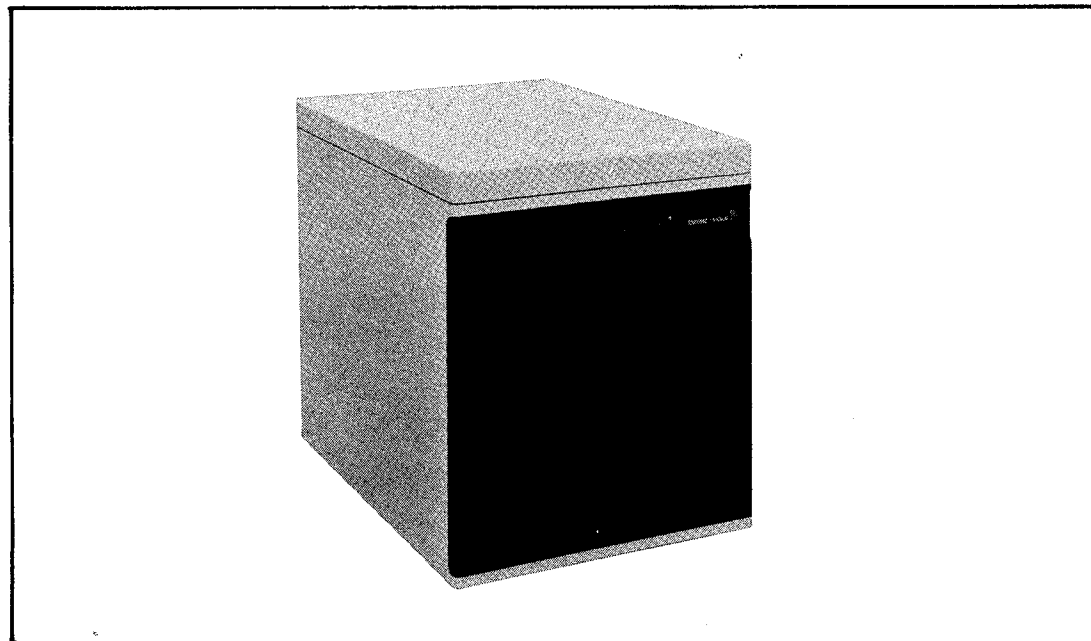

Figure 3. Central processing unit

The disc is a rotating metal platter having two magnetized surfaces for storing data. Discs are usually stored in sets of 4 in a disc pack. The disc pack drive, not pictured here, operates inside the central processing unit housing.

Magnetic Tape Cartridge Drive Unit

The magnetic tape cartridge drive unit holds the tape cartridge that stores a copy of the operating instructions and copies of the program and data on the disc (Figure 4).



Figure 4. Magnetic tape cartridge drive unit

Printer

The printer produces single page and multipart invoices, statements, checks, and reports. It can also give you a written record of your data processing activities (Figure 5).

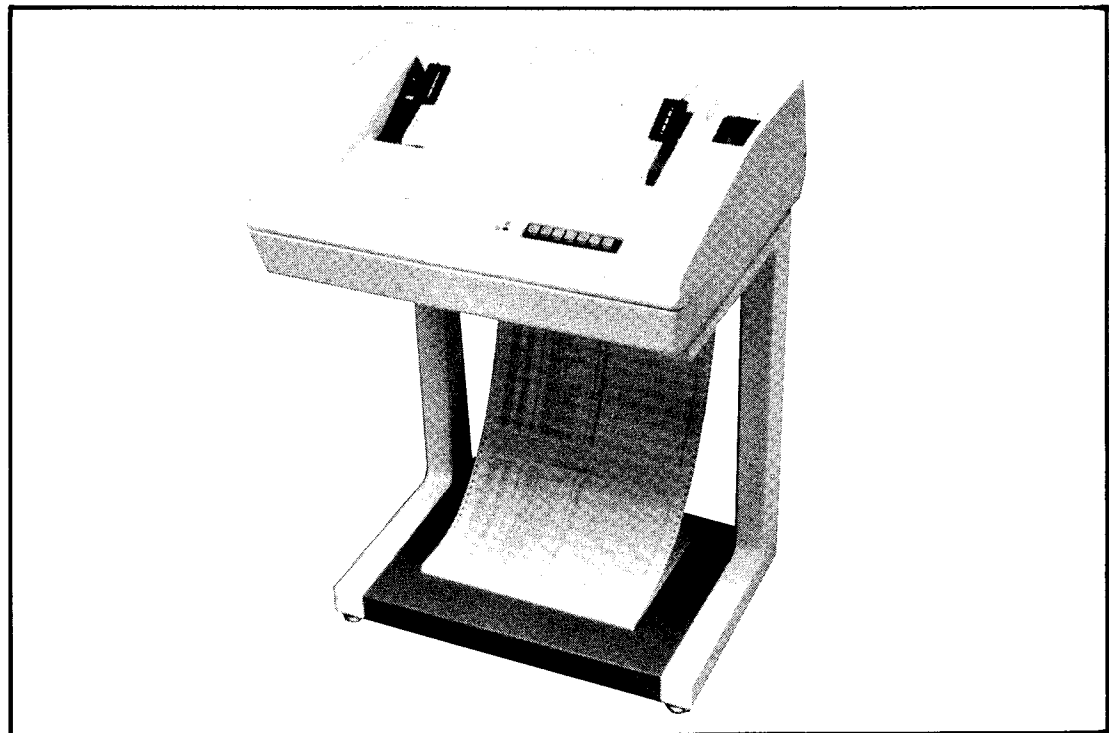

Figure 5. Printer

SOFTWARE

What Makes It Work? The BOSS

BOSS is the Basic Operating System Software. The operating system of any computer consists of programs that monitor and control all the computer's activities. The Basic Four System 200/410 operating system is known formally as "BOSS Level 3." Three important elements within BOSS exist for special purposes, but function in conjunction with one another.

Executive

The EXECUTIVE is the traffic director of the operating system. It schedules all input/output operations, including printer access and video display terminal communication, and keeps track of the data stored on disc, magnetic tape cartridges, and other storage media.

Interpreter

The INTERPRETER, another component of BOSS, converts the written English you enter through the video display terminal keyboard into machine-level language to allow you to communicate with the central processing unit.

Configurator

The CONFIGURATOR is the portion of BOSS that lets the Executive know what hardware and software components are attached to and controlled by the central processing unit. These components include the video display terminals, magnetic tape cartridge drive, the printer, and memory.

TWO MEMORIES

The central processing unit has two major memory divisions.

Operating system memory

The operating system, BOSS, resides in an area in the CPU called "protected" memory.

User memory

Information entered through use of the VDT keyboard is stored in the CPU in an area called "user" memory.

HOW THE SYSTEM WORKS*CPU directs traffic*

The System 200/410 hardware components are connected to the central processing unit rather than directly to each other (see Figure 6). This relationship means that all information goes through the CPU.

VDT gives you access

When the system is turned on and the CPU is ready to operate (in a RUN status), all instructions necessary to run the computer programs and all information to be processed are entered into the system through the VDT. You enter instructions and information by using the VDT keyboard.

Disc operates automatically

When a program is being run, the CPU automatically transfers information to and from the disc and the printer without any special requests from you via the VDT. You do not need to operate the disc drive independently, because the disc is automatically brought to a ready state when you turn on the CPU.

You start the printer

You'll need to place the printer "on-line" to the CPU--connect it logically--to be able to print. The printer receives your instructions via the CPU.

You prepare the magnetic tape unit

You'll need to insert the magnetic tape cartridge properly into the tape drive unit so that information can be transferred to and from the disc via the CPU.

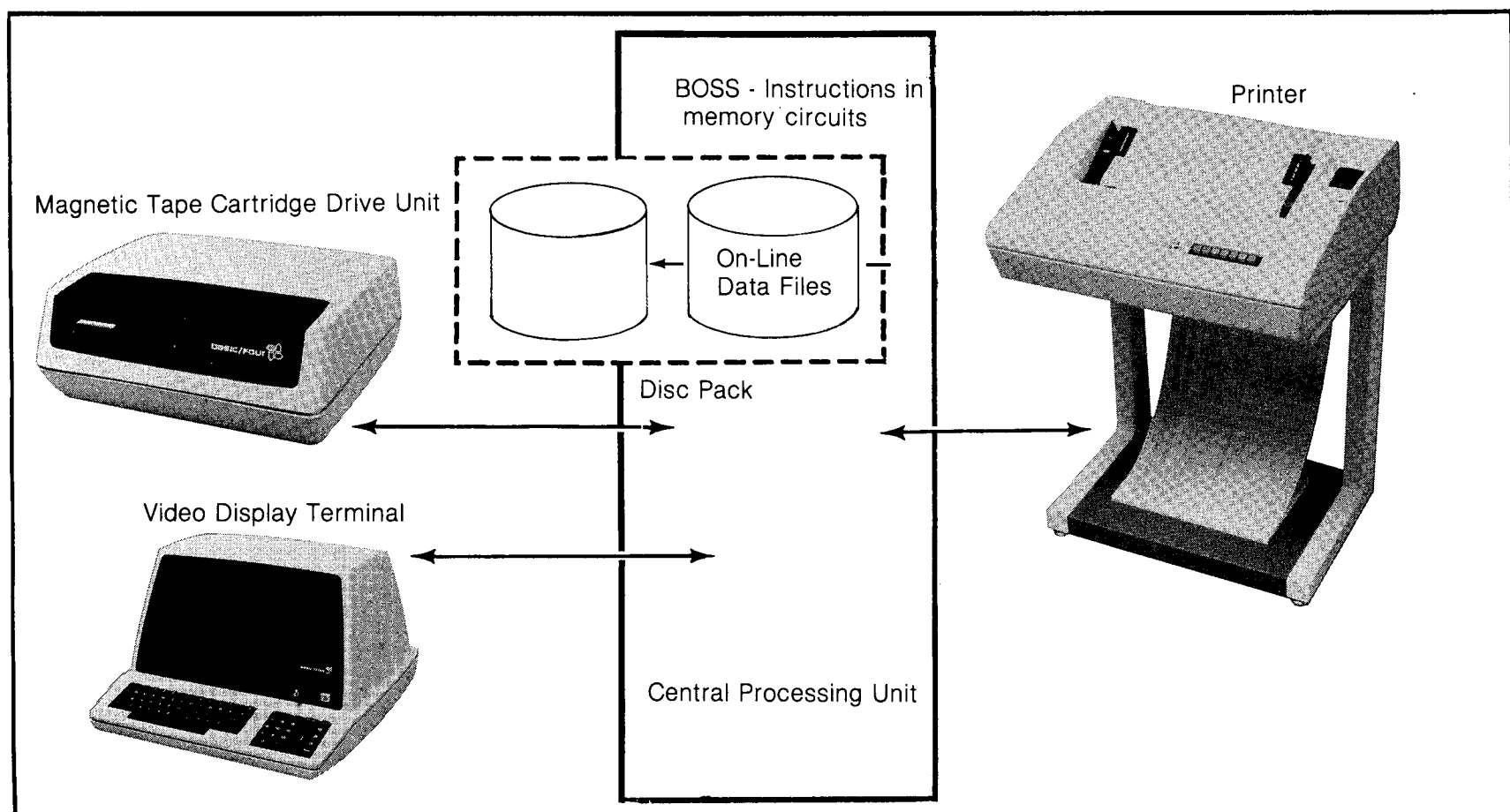

Figure 6. System 200/410 components: working relationship

TURN-ON SEQUENCE

Always turn on the System 200/410 in the following order:

- Step 1. Video display terminal (VDT)
- Step 2. Central processing unit (CPU)
- Step 3. Magnetic tape drive unit
- Step 4. Printer

Video Display Terminal

Power Turn on the video display terminal ON-OFF switch. Within about 20 seconds you'll hear a "beep" and see a small white box--the cursor--appear in the upper left corner of the screen (Figure 7).

Cursor The cursor serves to indicate where the next character will appear on the screen.

Screen brightness The brightness of the screen is controlled by a knob to the left of the on-off switch on the VDT. If you don't see the cursor and the entire display is blank, try adjusting the BRIGHTNESS control (Fig.7): turn the knob clockwise to make the screen brighter, counterclockwise to make the screen darker. If you turn the knob too far clockwise, a series of lines will appear on the screen; this is normal, simply adjust the knob back the other direction.

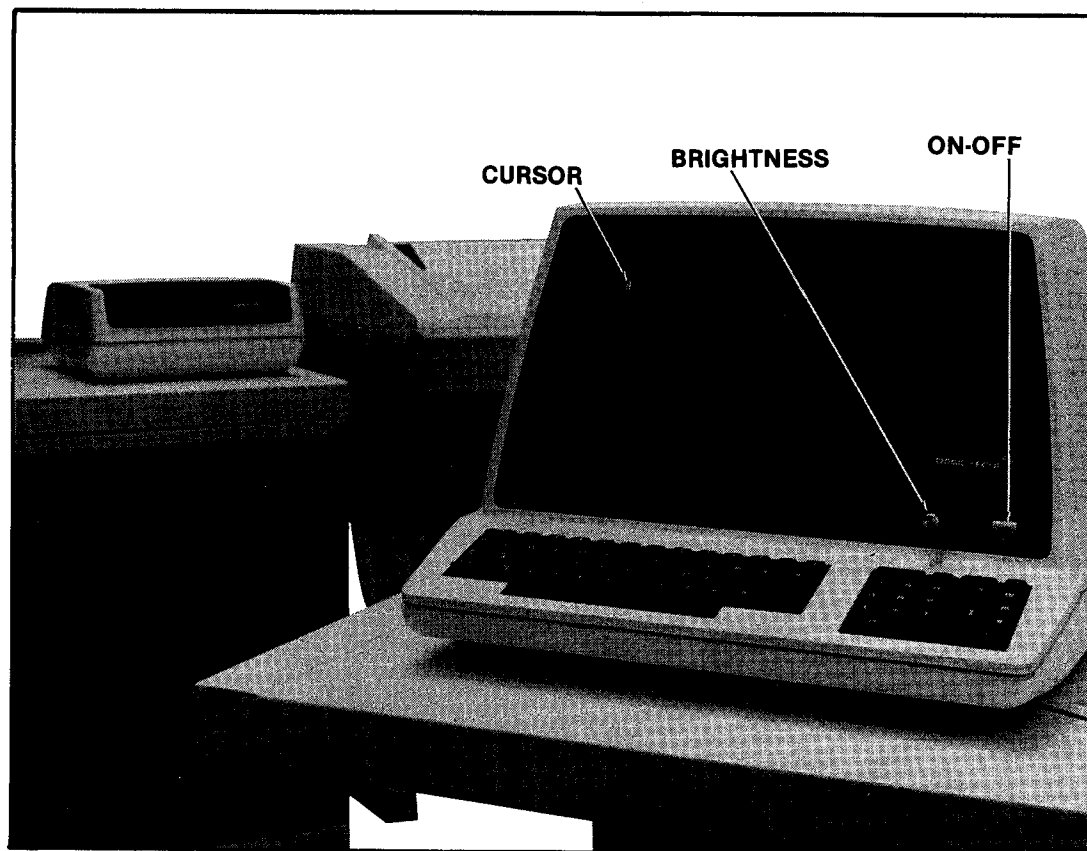

Figure 7. VDT front controls

No visible cursor

If the cursor still doesn't appear, turn off the VDT and call your Customer Service Representative (410 users call Sorbus Representative).

Central Processing Unit
CPU control panel

On the central processing unit (CPU), the front control panel contains a number of switches and status lights. You won't actually see the switches, which are behind the panel (Figures 8 and 9).

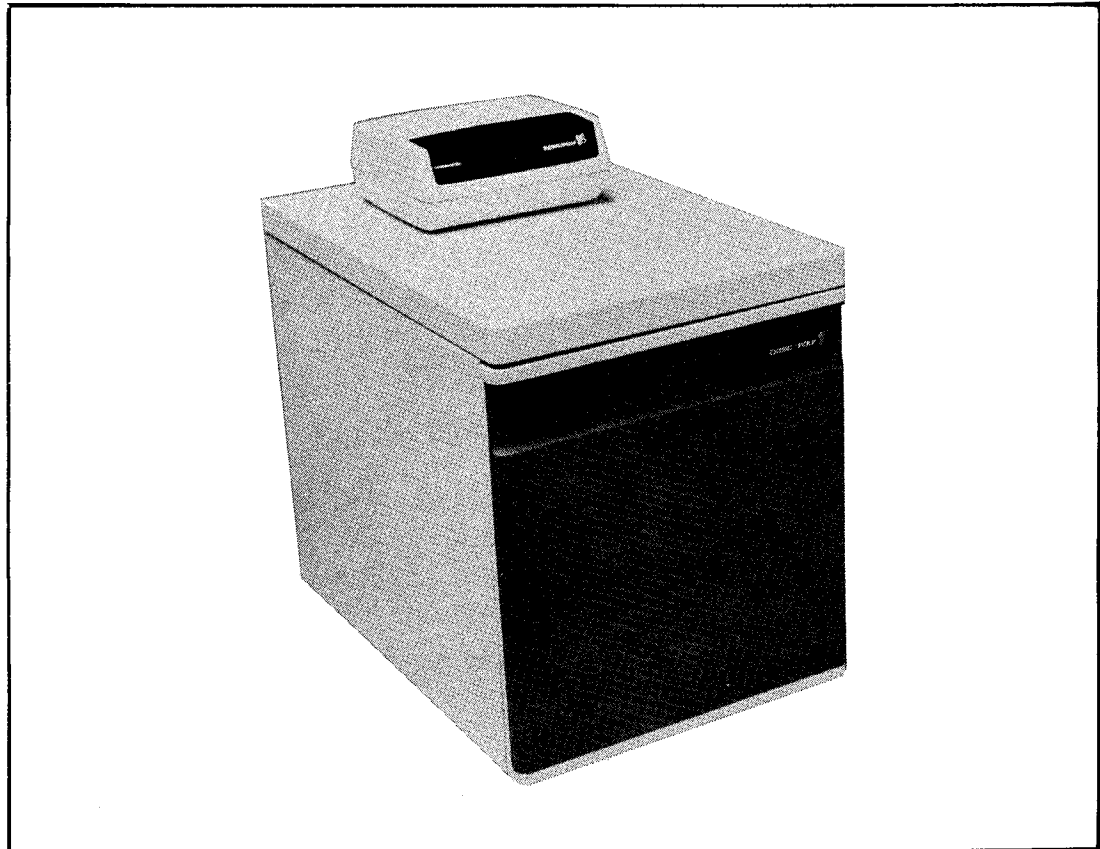

Figure 8. Central processing unit

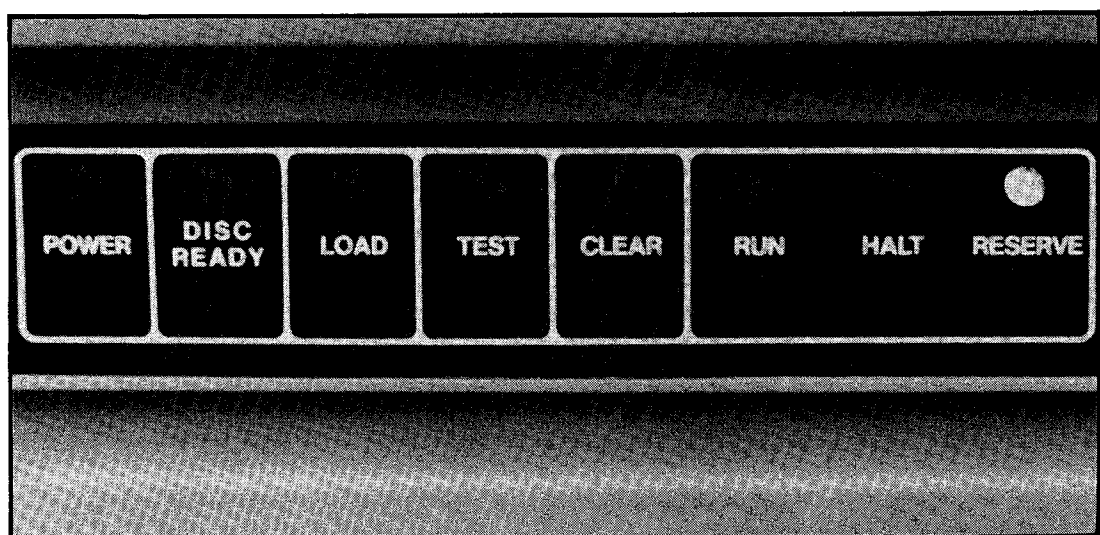
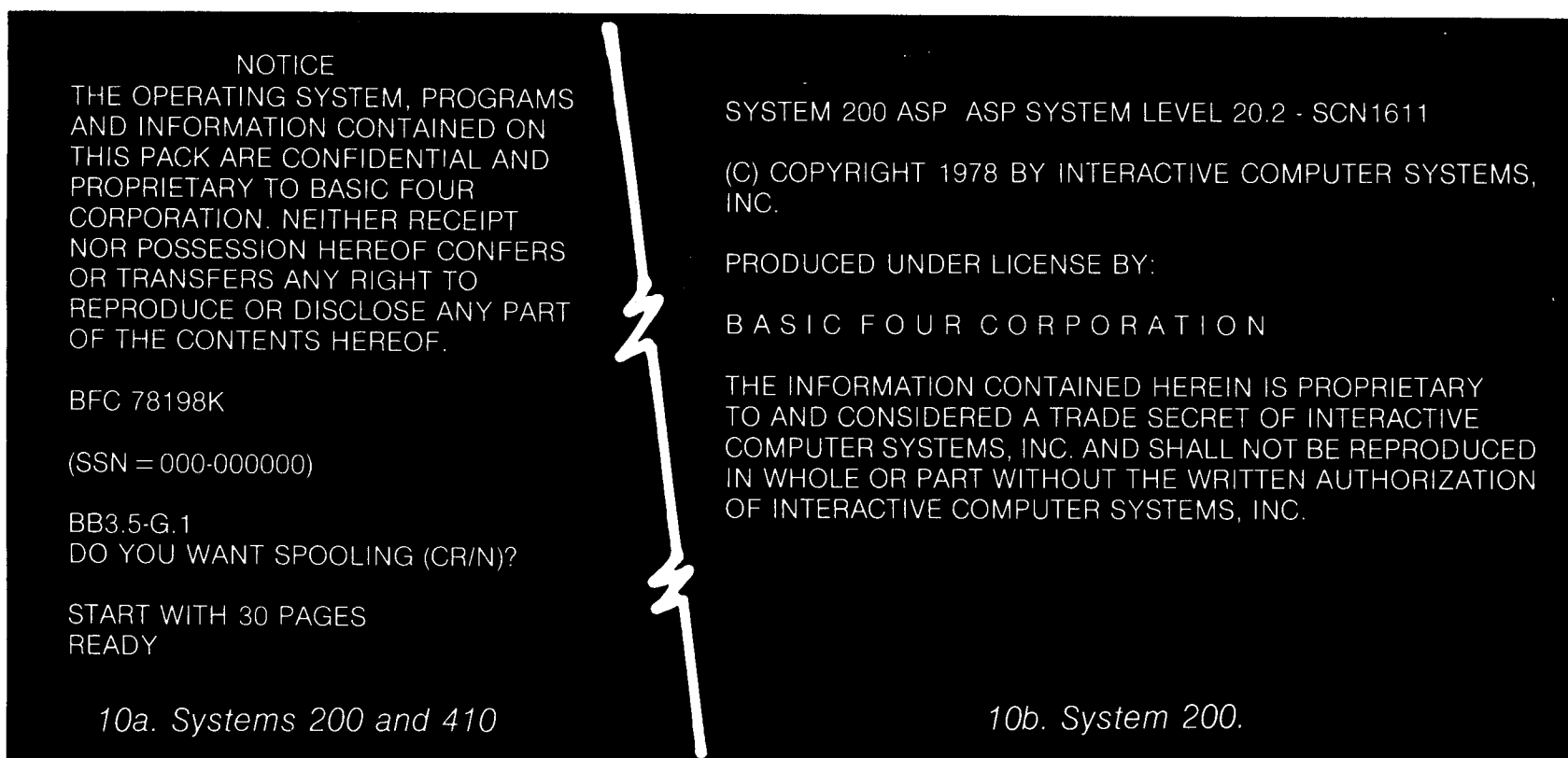

Figure 9. CPU control panel

BASIC OPERATING PROCEDURES

- Reserve indicator* Make sure the yellow light is on above the RESERVE indicator.
- No visible reserve light* If the yellow RESERVE light is not on, make sure the computer is plugged into an electrical outlet that is providing power. If there's still no response, call your Customer Service Representative (or Sorbus).
- Loading the CPU* To turn on, or load, the central processing unit's operating system, follow the steps below:
- Power* 1. Lightly touch the switch marked POWER, just beneath the word "power." A faint green light will appear.
- Disc ready* 2. A green light will also show over DISC READY.
- Load, run* 3. Then touch the LOAD switch for 1 second. This causes the entire BOSS operating system to be loaded from disc to memory. A green light will appear above RUN, and you'll hear a beep.
- Red halt light* If a red light appears over HALT instead of a green light over RUN, repeat Step 1. If there's still no green light response, call your Customer Service Representative (or Sorbus).
- Message on VDT screen* 4. After the beep, a proprietary message appears briefly on the VDT screen (Figure 10a). System 410 users need to answer the question on spooling. System 200 users will see, after about 3 seconds, a second message (shown in Figure 10b).



-
5. System 410 users: DO YOU WANT SPOOLING (CR/N)? Press RETURN for yes, "N" for no; ask your software programmer whether you should select spooling or not. The VDT will then display, "START WITH 30 PAGES. READY."

CPU ready to use

Your central processing unit is now ready to use. It will wait for your instructions.

CAUTION

If the load procedure from disc is not successful after several attempts, call your Customer Service Representative or Sorbus Representative. The operating system may need to be reinstalled, or a hardware problem may exist.

CAUTION

Do not move the CPU cabinet. Only qualified service personnel should relocate the CPU cabinet because mishandling could seriously damage the unit.

Summary: CPU controls

POWER--Turns power to the CPU on and off

DISC READY--This green display light indicates that the disc inside the CPU is ready.

LOAD--Tells the computer to load all the information needed to process (or run) your accounting activities

TEST--Used to load the alternate operating system for backup (see Section 5)

CLEAR-- Should be used ONLY by your Customer (or Sorbus) Service Representative. It is used for testing the system.

RUN--Green light indicates the computer is ready to run.

HALT--Red light indicates the CPU has stopped.

RESERVE--Yellow light indicates that the backup battery supply is available if it should be needed.

Backup battery

The yellow RESERVE indicator will normally always be lit, indicating the battery is in a charged state. Interruption of AC power to the system activates battery backup circuits, which then supply power to the main memory for three to four hours. (Turning the CPU on or off with the POWER switch does not activate the backup battery.)

CAUTION

When AC power to the system is interrupted, the battery will supply power to maintain CPU main memory circuits for three to four hours. You'll need to make sure that regular AC power is restored within that three-four hour period, because after the battery is discharged, the RESERVE indicator will go off and contents of the CPU memory will be lost. This total loss of power, however, will not cause loss of disc storage memory or data backed up on tape cartridges.

Disc Drive*Disc drive functions*

One disc drive comes with each System 200/410 and is enclosed in the same cabinet with the CPU. Associated with the disc drive is a microprocessor-based controller that performs selected error checking and correcting routines and controls data transfers between the CPU and the disc.

Disc drive operation

The disc drive operates unattended and is activated when the system is started up. Electrical power to the disc drive is controlled by the main POWER switch on the front of the CPU.

WARNING

Avoid touching the disc drive mechanism. Ordinarily this mechanism is never accessible to the operator. If by chance the CPU cabinet should be opened, do not touch the disc drive mechanism because an electrical hazard exists. Simply close the cabinet before operating the system.

Data storage disc

The System 200/410 uses a disc pack containing four platters (discs). The two center discs are used for data storage; the top and bottom discs serve as protective surfaces.

CAUTION

Do not touch the discs. The data storage disc pack must not be removed except by an authorized service representative.

Magnetic Tape Cartridge and Drive Unit*Function*

The tape cartridge provides an economical means of storing medium volumes of data. The tape cartridge is used to store a copy of the operating system and copies of the programs and data contained on the System 200/410 disc. This capability gives you a backup should any portion of the disc or disc drive malfunction and require reloading. Basic Four Corporation thus recommends that you copy (or back up) your files daily onto a magnetic tape cartridge (Figure 11).

Operation

The tape cartridge drive unit has been designed to permit easy operation. After you turn on the unit, its operation is controlled by the CPU. The unit can conveniently be placed on top of the CPU.

Safety lock

A special safety lock on the tape cartridge prevents you from accidentally entering new data that erases existing data (Fig. 12). When the arrow on the lock points to SAFE, the tape is in a protected or READ-

ONLY status. Use a thin coin or screwdriver to turn the lock on or off. When the lock is off (arrow pointing away from SAFE), you can enter new data on the tape.

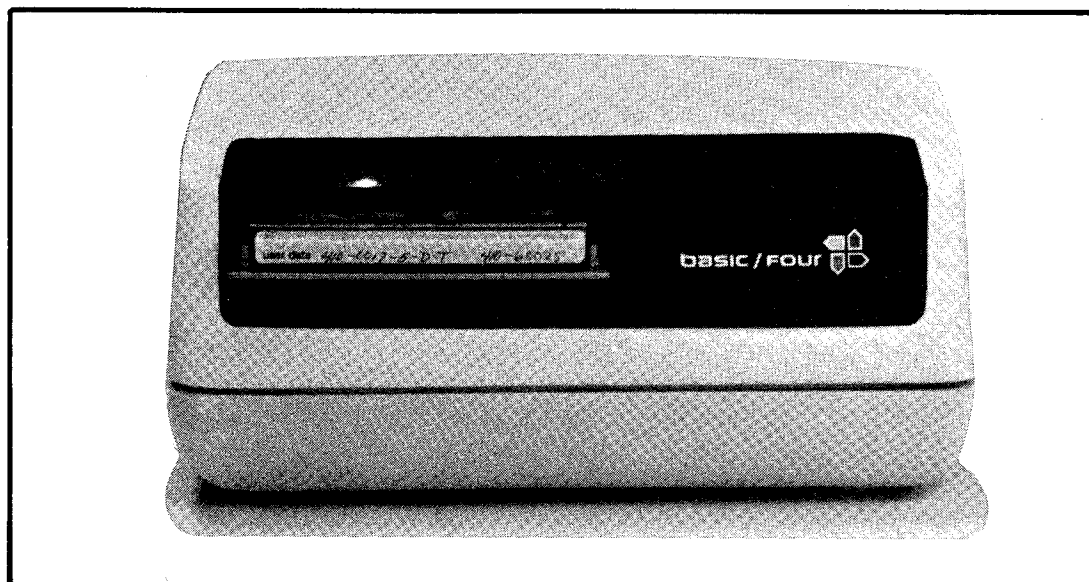

Figure 11. Magnetic tape cartridge drive unit



Figure 12. Tape cartridge safety lock off (read-write position)

Turning on the tape cartridge drive

Turn on the tape cartridge drive unit by turning up the POWER switch at the rear of the unit (Fig. 13). You'll see a light come on in the cartridge loading area and hear the unit's fan motor start.

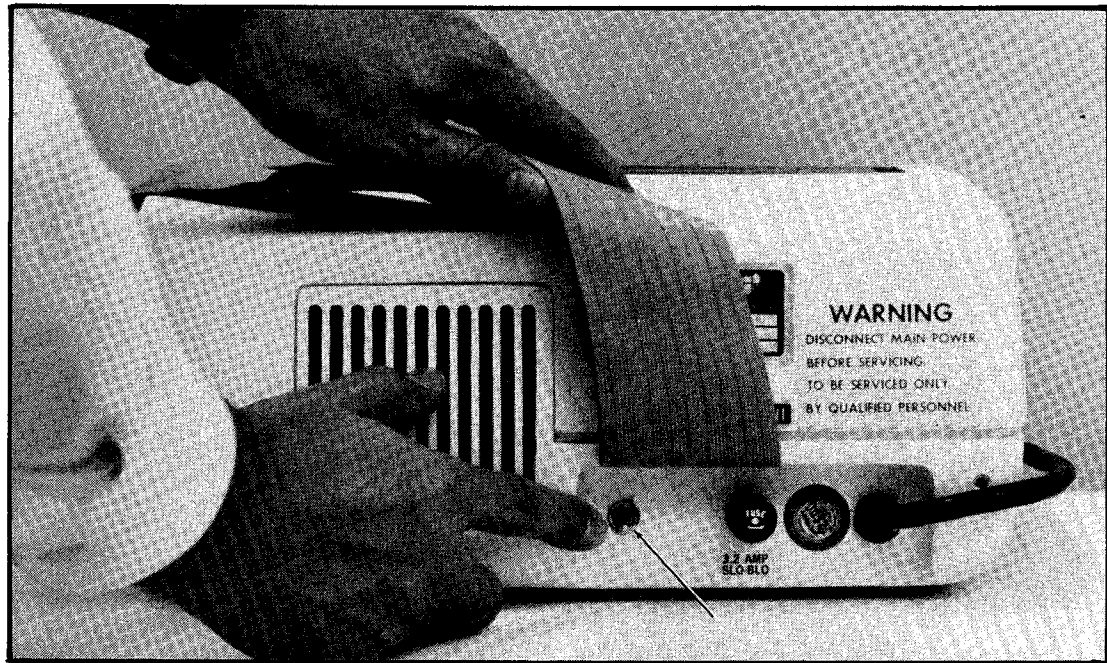

Figure 13. Tape cartridge drive power switch

Tape cartridge drive not working

If the unit's fan or light doesn't come on, make sure the unit is plugged in. If there's still no response, call your Customer (or Sorbus) Service Representative.

Inserting cartridge

Place the tape cartridge at the front opening of the drive unit, clear plastic side up and the edge with the small hinged plastic door pointing toward the rear of the drive unit. Slide the cartridge into the drive unit until a firm stopping point is felt. Press firmly into position (Figures 14 and 15).

Rewinding

As a tape system operation ends, the CPU automatically issues a rewind command without operator participation. A photo sensing unit detects a stop signal at the beginning of the tape so that rewinding stops before the tape is pulled completely from the take-up hub. Then the tape drive advances the tape briefly. Similar signals occur on the tape at the "Load Point," "Early Warning," and "End-of-Tape" positions.

Removing cartridge

To remove the tape cartridge, wait until the rewind procedure is completed. As you begin to pull the tape cartridge from the front of the unit, a release lever is actuated and the cartridge is automatically ejected.

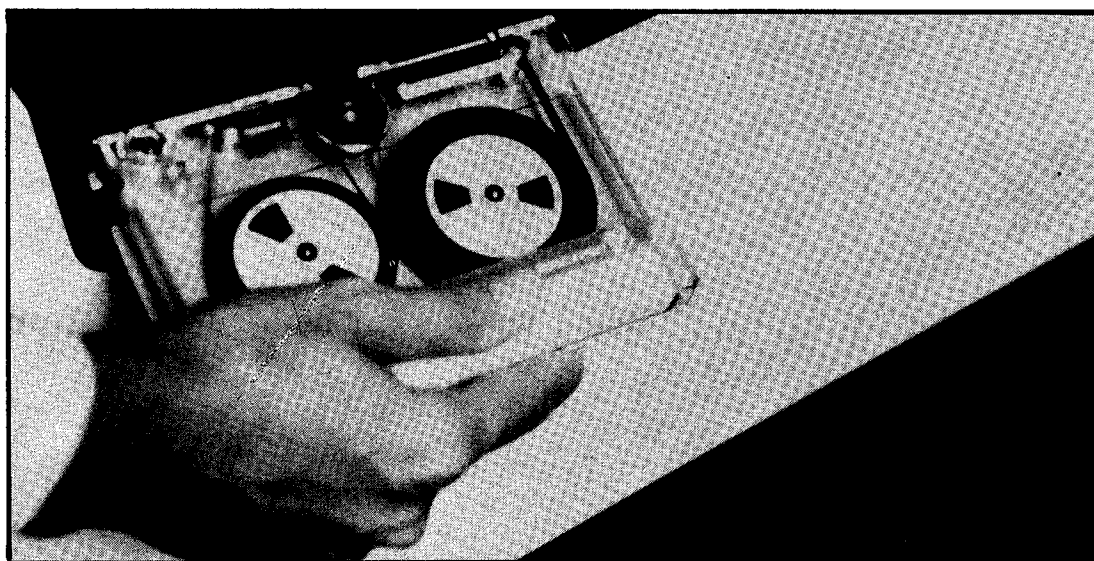

Figure 14. Inserting tape cartridge

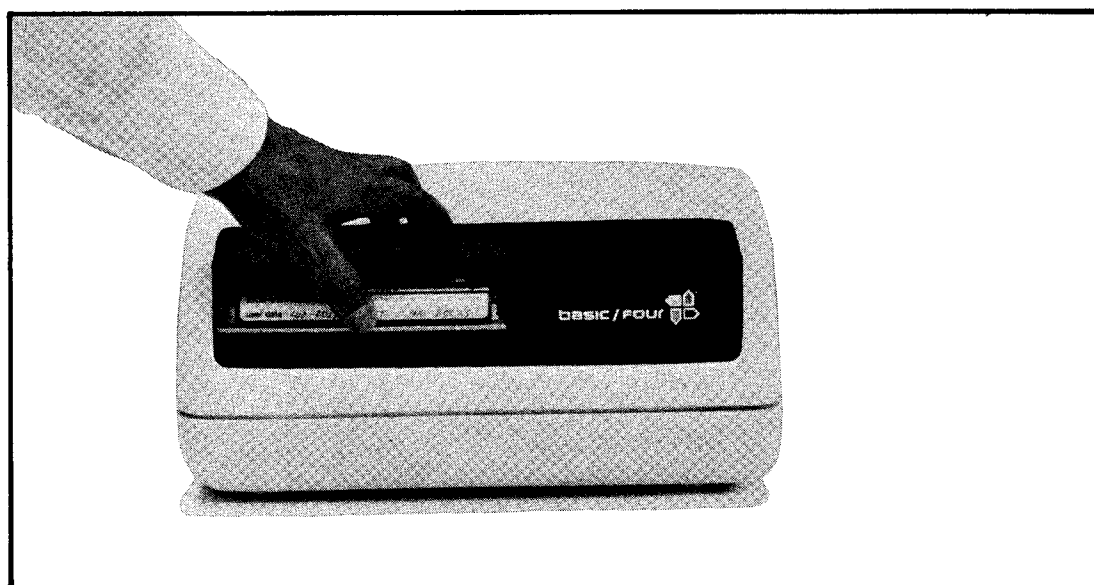

Figure 15. Inserting tape cartridge

Backup procedures

Your Customer (or Sorbus) Service Representative will explain how to carry out the procedures needed to back up information from disc to tape. For your reference these instructions are also included as Section 5 in this guide.

Dust-proof container

When the tape cartridge is not in use, protect it against dust by storing in the plastic dust-proof container and special cardboard container that come with the cartridge.

Extra dust protection

A hinged plastic door on the tape cartridge drive unit gives additional protection against contamination of the tape cartridge. When you remove the cartridge from the drive unit, the plastic door closes, preventing dust from entering the tape head/tape operation area.

PRINTER

Control switches are on top of the printer at the right front side (Figures 16 and 17).

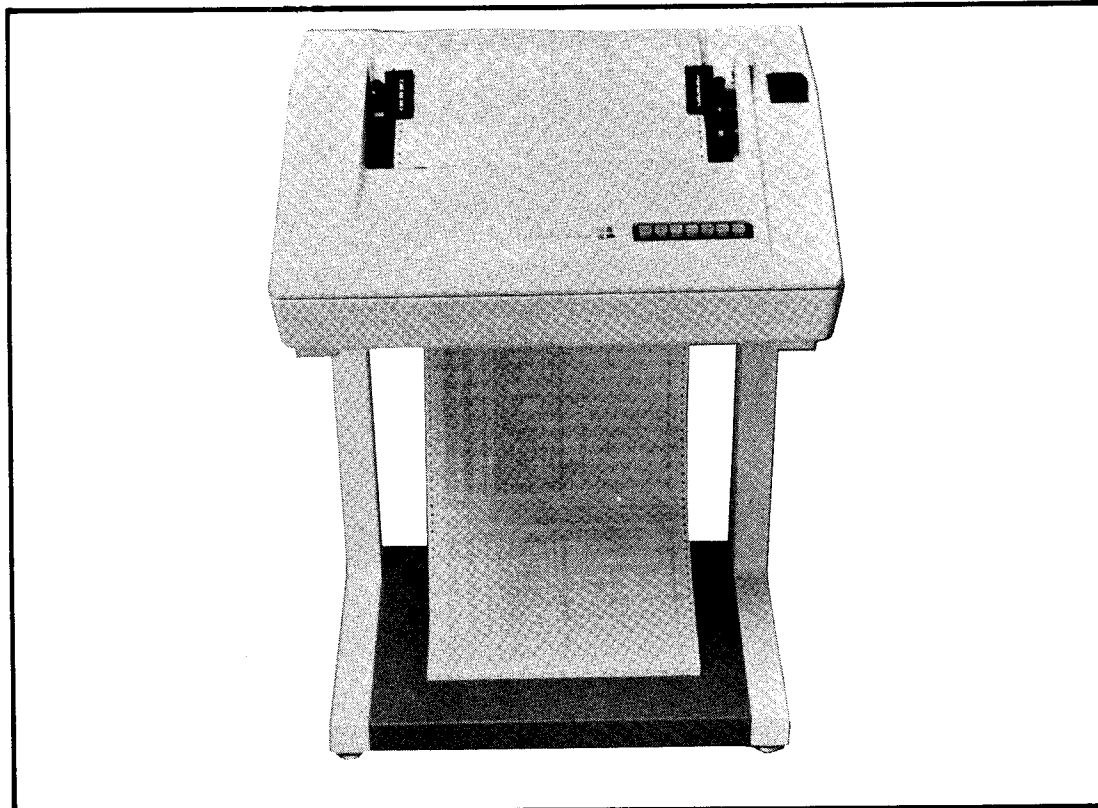

Figure 16. Printer

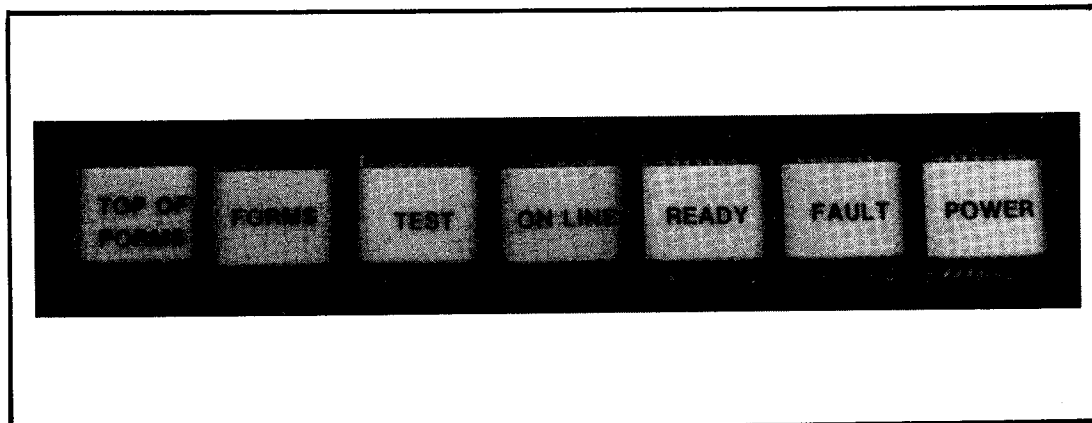

Figure 17. Printer controls

Turning power on

Press the POWER switch on. The POWER indicator light will come on, and you'll hear a beep and the sound of the printer motor.

Head test

The PRINTER HEAD will automatically move slowly from left to right, then back to the left. It will then make a quick left-right-left movement (Figure 18).

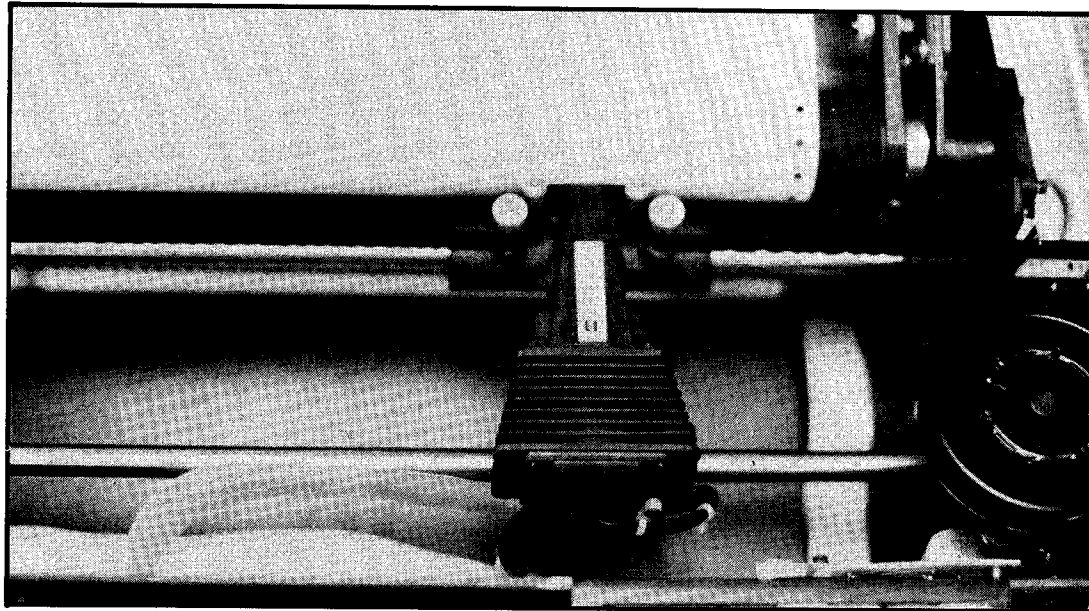

Figure 18. Printer head (unit cover open)

Printer head not moving

Turn to Section 6, Procedural Errors.

Top of form and ready switches

The TOP OF FORM and READY lights will come on. Briefly pressing the TOP OF FORM switch causes the paper to advance to the top of form (page). (This switch doesn't function when the ON-LINE light is on.)

Paper loading

If the printer doesn't have paper in it, load paper at this point. See Section 7 for instructions on loading paper and changing the printer ribbon.

On-line switch

Press the ON-LINE switch, and the lights will come on. The printer, now able to receive instructions from the CPU, is ready for you to use.

Other printer controls

Forms

The FORMS indicator light comes on when the paper supply runs out. See Section 7 on loading paper.

Test

If the ON-LINE light is not lit, you can press the TEST switch to cause a test pattern to print continuously. Press it again to stop the test pattern; the TEST switch must be off before you go ON-LINE again.

Error

The ERROR indicator light comes on if an error occurs in the system.

SUMMARY: TURN-ON SEQUENCE*Video display terminal*

- Turn on the VDT.
- Press ON-OFF switch to ON.
- The VDT speaker will beep.
- A small WHITE box (the cursor) will appear on the screen.

Central processing unit

- Turn on the CPU.
- Make sure YELLOW RESERVE light is on.
- Touch POWER switch.
- GREEN lights come on over POWER, RUN, and DISC READY.
- Touch LOAD switch.
- The VDT speaker will beep.
- A message will print quickly on the VDT screen.
- Another beep sounds; then a second printed message appears. (410 users answer the spooling question contained within the first message.) The START and READY messages appear.)

Magnetic tape cartridge drive unit

- Turn on the MAGNETIC TAPE DRIVE UNIT.
- Flip ON-OFF switch UP to ON position.
- A light comes on in the cartridge loading area.
- The unit fan comes on.

Printer

- Turn on the PRINTER.
- Press POWER.
- POWER light comes on.
- PRINTER speaker beeps.
- PRINTER HEAD moves left-right-left, first slowly, then quickly.
- TOP OF FORM and READY lights come on.
- Press ON-LINE.
- ON-LINE light comes on.

SUMMARY: TURN-OFF SEQUENCE*Video display terminal*

- Press the ON-OFF switch to OFF.
- The VDT speaker beeps, the image disappears from the screen.

Central processing unit

- Press the POWER switch.
- All lights go off except the yellow reserve light.
- The fan in the unit goes off.

Magnetic tape cartridge drive unit

- Remove the tape cartridge if it is still in the unit. Failure to do so can result in erasure of information on the tape.
- Flip the POWER switch to the DOWN position for OFF.
- The light and the fan go out.

Printer

- Press the POWER switch.
- All lights in the printer go out.
- The fan in the unit goes off.

CAUTIONS

VDT

DO: Turn the power on before you try to use the terminal.
Make sure the plug is plugged into the wall outlet.
Clean the VDT screen with glass cleaner and a soft cloth.

DON'T: Drink any beverages over the keyboard.
Eat over the keyboard.
Leave the terminal turned on overnight unless you have some specific reason.
Hit the VDT screen.
Remove the cover from the VDT.
Lean on the terminal keys.
Use rough materials to clean the screen - it's easily scratched.

CPU

DO: Make sure the CPU is plugged in.
Make sure the Yellow RESERVE light is on.

DON'T: Leave any beverages on the CPU.
Hit the CPU. The disc inside is sensitive to movement.
Move the CPU while it is running.
Remove or open CPU panels or cabinets.

TAPE UNIT

DO: Make sure the tape unit is plugged into the wall outlet.
Keep tape cartridges in a clean area.
Keep tape cartridges in a safe area--dry, moderate temperatures.

DON'T: Blow smoke at the tape cartridge.
Drop the tape cartridge.
Spill any liquids on a cartridge.
Store cartridges near heat.
Play with the small hinged door in the back of the cartridge.

PRINTER

DO: Make sure the printer is plugged in, using a 3-wire grounded outlet.
Make sure you have enough paper before you start printing.
Make sure the front of the paper (with blue bars showing) faces you when loading.
Make sure all covers are closed and secured during operation.

DON'T: Spill any beverages in the ON-OFF Switches.
Change ribbon with the power ON.
Let ties, necklaces, long hair, or loose clothing, etc., dangle near the printing mechanism.
Operate without paper.
Let the printer run unattended.
Exceed paper thickness of more than five sheets (total thickness not to exceed 0.040 inch).

VDT KEYBOARD

In this section you'll read in detail about how to use the video display terminal to communicate with the computer. The System 200/410 display terminal keyboard has two distinct sections: the TYPEWRITER keyboard and the NUMERIC keyboard. These are shown in Figure 19. Continue to refer to this illustration as you learn the VDT keys.

Typewriter-like keyboard

The keys on the VDT keyboard operate as do the keys on your office typewriter--with a few exceptions. Usually all the letter keys produce capital letters, and all the number keys produce regular numbers on the VDT and on the printer. You can use the number keys on the typewriter keyboard interchangeably with the number keys on the numeric keyboard.

Control keys

In addition to the letter and number keys, the VDT keyboard has certain keys that control the information that is input and displayed on the screen. Some of these control keys are used frequently, some infrequently.

FREQUENTLY USED KEYS

You'll read in detail about the following nine keys in the next few pages. As you read about each key, note its purpose and its location in the illustration. DO NOT PRESS the key until instructed to do so.

- | | | |
|--------------|------------------------|------------------------|
| 1. CR/ENTER | 4. I - FIRST CONTROL | 7. IV - FOURTH CONTROL |
| 2. BACKSPACE | 5. II - SECOND CONTROL | 8. DECIMAL POINT |
| 3. SPACE BAR | 6. III - THIRD CONTROL | 9. SHIFT KEY |

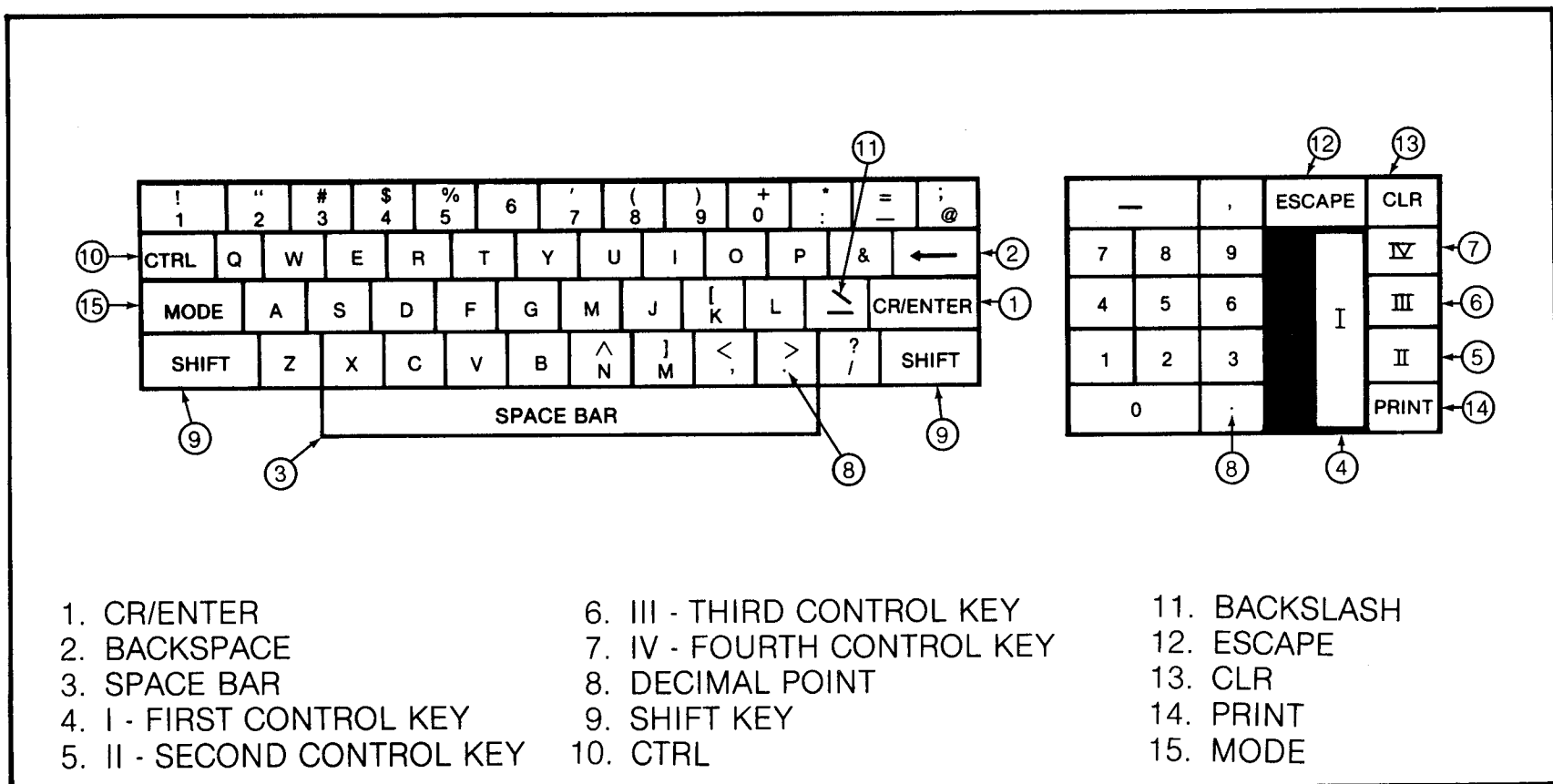

Figure 19. VDT keyboard

1. *CR/ENTER* key

This is the CARRIAGE RETURN/ENTER key. When you enter information into the computer, you can type anything you wish. What you type appears on the screen, where you review it. If needed, you can then correct errors or make changes, because the computer program won't act on your input UNTIL YOU TELL IT TO DO SO.

Use of CR/ENTER key

Use the CR/ENTER key to tell the computer that you are ready for it to act on the data just typed (entered). If you enter something and nothing happens, you may have forgotten to press the CR/ENTER key. REMEMBER TO PRESS THE CR/ENTER KEY after entering information on the keyboard.

CR/ENTER key and cursor

Use the CR/ENTER key to move the cursor down to the beginning of the next line (field) before beginning to enter information or continuing to enter information.

2. *Backspace* key

Use the BACKSPACE key to move the cursor to the left on a line or to correct a typing error. Each time the cursor is moved to the left, ANY LETTER REPLACED BY THE CURSOR IS DELETED and must be retyped to be re-entered into the computer.

3. *Space bar*

Use the SPACE BAR to move the cursor to the right, one space at a time. As on a standard typewriter, it is used to position letters properly on a line.

Control keys on numeric keyboard

4. *I - first control key*
5. *II - second control key*
6. *III - third control key*
7. *IV - fourth control key*

Four keys on the numeric keyboard are called "Control" keys. These keys have purposes that are easily described. Their USE, however, needs to be explained by the Customer (or Sorbus) Service Representative who will work with you and your System 200/410. The keys are numbered I, II, III, and IV and are sometimes called "Motor Bar" keys or MB keys. They are used in the same way as the CR/ENTER key.

8. *Decimal point key*

The decimal point is found on both the typewriter and numeric keyboards. On both it functions as a "period" to end a sentence and as a decimal point in decimal arithmetic, as in dollars and cents (\$4.15).

9. *Shift key*

The SHIFT key is used in conjunction with the letter and number keys to print special characters that appear ABOVE certain letters and numbers. For instance, both the dollar sign \$ and the number 4 appear on one key. To type "\$" hold down the SHIFT key and depress the 4/\$ key.

INFREQUENTLY USED KEYS

You normally will not use the group of keys described below. But you should be aware of what they do and where they are located on the keyboard. Sometimes your Customer (or Sorbus) Service Representative might ask you to use one for diagnostic purposes. Refer to Figure 19 for key locations.

- | | |
|---------------|-----------|
| 10. CTRL | 13. CLR |
| 11. BACKSLASH | 14. PRINT |
| 12. ESCAPE | 15. MODE |

10. *CTRL key*

The CTRL or CONTROL key, when held down while you press any other typing key, causes an unprintable character to be created. Nothing will be printed on the screen. Do not use this key unless instructed to do so by your Customer (or Sorbus) Service Representative.

11. *Backslash*

Do not use the BACKSLASH key on the System 200/410.

12. *ESCAPE key*

Do not use the ESCAPE key on the System 200/410 except under the direction of a qualified programmer.

13. *CLR key*

The CLEAR key clears the VDT screen. Whatever is on the screen disappears, and the cursor returns to the upper left corner of the screen. Use this key only when instructed to do so by your Customer (or Sorbus) Service Representative.

14. *PRINT* key

Do not use the PRINT key on the System 200/410.

15. *MODE* key

The position of the MODE key determines whether letters print in the upper or lower case. With the key up, upper case letters are displayed. If the upper case–lower case option has been implemented, normal lower case letters display when the key is pressed down (otherwise, reverse print letters display).

Mode option

If you have chosen this option to be available on your system, you'll select lower case letters by pressing the MODE key down.

COMMON TYPING ERRORS

Figure 20 shows some examples of numbers and letters that look alike on the VDT screen. They are NOT interchangeable, and errors can occur if you mistakenly type one instead of another. Note that the printed zero has a slash through it although the keyboard zero does not.

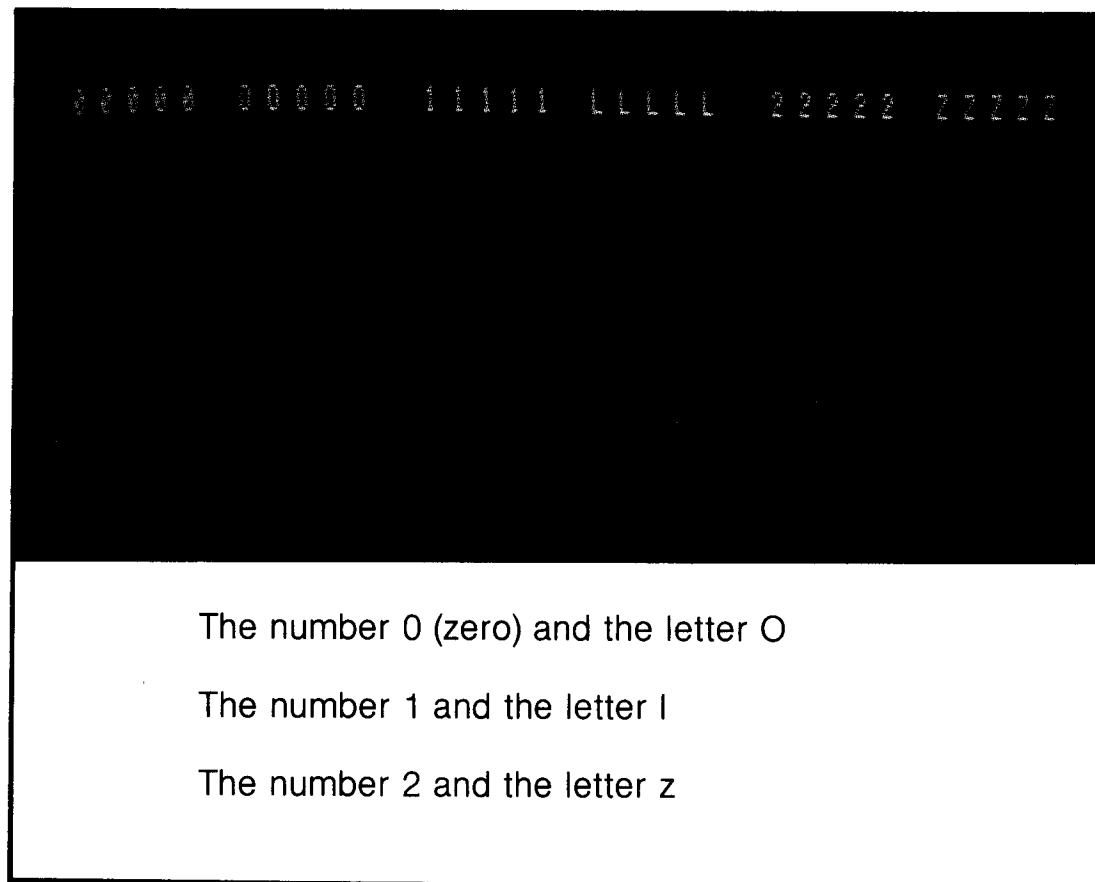

Figure 20. Common typing errors

SYSTEM 200 UTILITIES

A UTILITY program is a general purpose computer program used to determine the contents or status of certain parts of the system. You need to know about utilities so you can run them for your Customer (or Sorbus) Service Representative to assist in solving some problems.

Three utilities

The three programs described in this section help you get general directory or file information from the computer. They provide three different types of listing:

- Print disc directory on the printer--program *A
- Display disc directory on the VDT--program *L
- Display file information on the VDT--program *F

**PRINT DISC DIRECTORY -
*A**

The disc directory includes every program and file on the disc. To obtain a printed copy of this directory, you must choose utility program *A (Figure 21):

1. Type on the VDT keyboard: **RUN “*A”**. Type as shown, including the quote marks. The asterisk appearing on the screen will look more like this--*--than a typewriter asterisk.)
2. Press the CR/ENTER key.
3. Type 0 (zero) to enter the disc number.
4. Press the CR/ENTER key again.

What happens?

The VDT screen displays the following message, asking for your response (note the slash mark to the right) (Figure 22): Enter Disc ID (CR = NONE).

Your response

Type your name or some other short message. Make sure your message doesn't extend beyond the righthand slash mark. Press CR/ENTER key.

What happens?

You can choose to have the directory listing sorted in one of three sequences. The system asks you which of the three listing sequences you want (Figure 23):

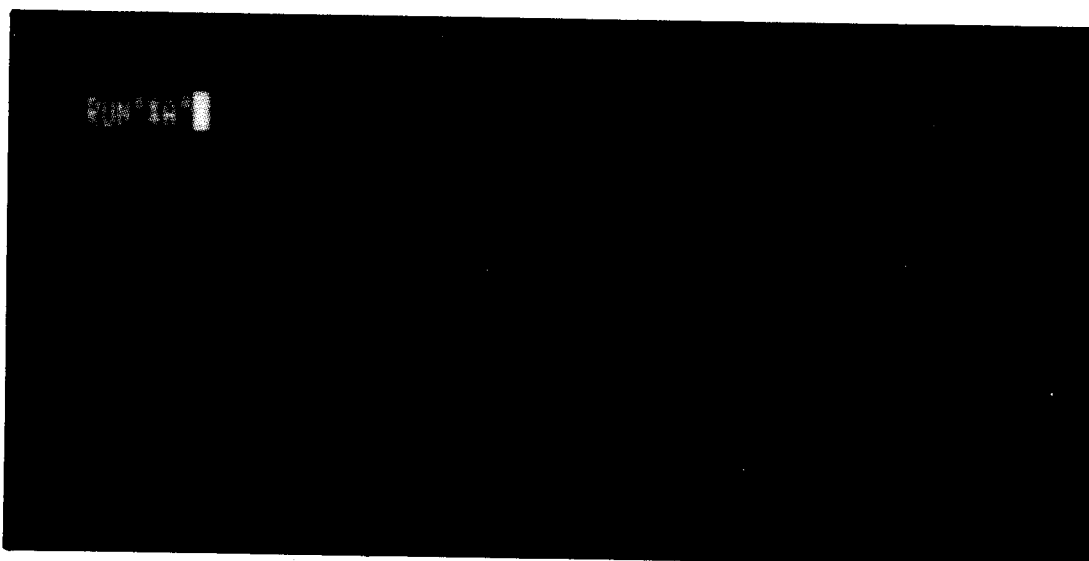

Figure 21. Choosing utility program *A

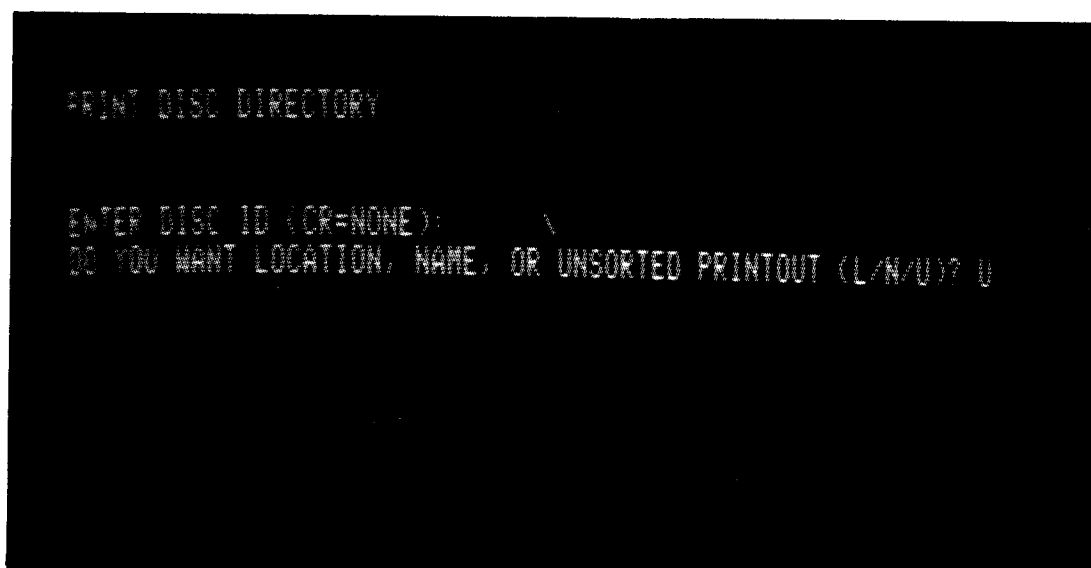

Figure 22. Entering disc i.d. to print disc directory

The system asks you which of the three listing sequences you want:

- Location--**Type L** to have the listing sorted in numerical order of program location on the disc.
- Name--**Type N** to have the listing sorted in alphabetical order by program name.
- Unsorted--**Type U** to have the listing printed without being sorted.

After entering your choice, press the CR/ENTER key.

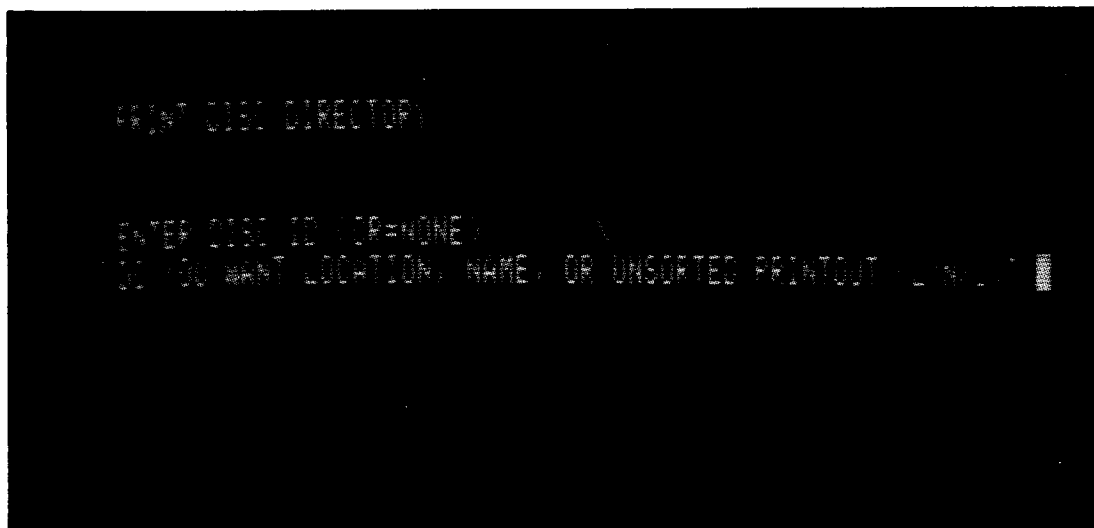

Figure 23. Choosing sequence of directory listing: unsorted

What happens?

The computer sorts all programs and files according to your input (L, N, or U). The sorting process can take as much as 5 minutes before actual printing begins. Then the printer begins printing the directory in the sequence you selected (Figure 24). When the listing is complete, the printer stops automatically.

DIRECTORY LISTING FOR DISC 0 S40129 11/10/78 8											
* AVAILABLE SECTORS											
FILE NAME	FILE TYPE	FIRST SECTOR	LAST SECTOR	TOTAL SECTORS	NO. OF RECORDS	BYTES/RECORD	KEY SIZE	AVAIL RECORDS	PROGRAM SIZE	PROGRAM IDENTIFICATION	
*SRCFL	IND	37	61	25	200	128					
BBIITC	IND	62	103	42	168	256					
OSBBII	IND	104	145	42	168	256					
OSMNTC	PGM	146	146	1	1	1024			230		"OSMNTC"SPECIALTAPECAR
OSMONR	PGM	147	147	1	1	1024			386		"OSMON "": (04/03/78 SS
FORMT2	PGM	148	150	3	1	3072			2284		10"FORMT2"2400 DISK F
*MTC	PGM	151	154	4	1	4096			3436		"*MTC"4-F"MTC BACKUP
*MTCR1	PGM	155	158	4	1	4096			2241		*MTCR1-4/6/78@1620-GTM
*MTCR2	PGM	159	160	2	1	2048			909		"*MTCR2"4-F"SELECTIV
*MTCR3	PGM	161	162	2	1	2048			1551		"*MTCR3"4-F"DIRECTOR
*MTCB1	PGM	163	164	2	1	2048			830		"*MTCB1"4-F"MTC BACK
*MTCB2	PGM	165	167	3	1	3072			2909		"*MTCB2"4-F"MTC BACK
SLA02	DIR	168	176	9	100	47	22	80			
		177	667	491*							
%DOF	IND	668	673	6	6	1024					
%D20	PGM	674	679	6	1	6144			5233		"%D20"4-F"09/27/77"
%D21	PGM	680	684	5	1	5120			4025		10"%D21"4-F"07/28/77
%D22	PGM	685	689	5	1	5120			4145		10"%D22"4-F"07/11/77
%D23	PGM	690	693	4	1	4096			3190		10"%D23"4-F"12/29/77
%D23-1	PGM	694	697	4	1	4096			3224		10"%D23-1"4-F"04-14-
%D23-2	PGM	698	702	5	1	5120			4175		10"%D23-2"4-F"04-14-
%D23-3	PGM	703	706	4	1	4096			3258		10"%D23-3"4-F"12/29/
%D23-4	PGM	707	710	4	1	4096			3525		10"%D23-4"4-F"12/29/
%D24	PGM	711	714	4	1	4096			3849		10"%D24"4-F"01/03/78
%D24-1	PGM	715	718	4	1	4096			3481		10"%D24-1"4-F"01/03/
%D24-2	PGM	719	723	5	1	5120			4690		10"%D24-2"4-F"07/11/

Figure 24. Directory listing: unsorted

DISPLAY DISC DIRECTORY ON VDT--*L

To view the directory listing on the VDT without obtaining a printed copy, you must choose utility program *L (Figure 25):

1. Type on the VDT keyboard: **RUN "*"L"**
2. Press the CR/ENTER key.

3. Type 0 (zero) to enter the disc number.
4. Press the CR/ENTER key again.

What happens?

The VDT screen displays the following message asking you to select which listing you want:

- Data files--**Type D** to have only the data files listed.
- Program files--**Type P** to have only the programs listed.
- Available sectors--**Type A** to have only the available sectors ("empty spots") on the disc listed. (You may need to know where you can enter a new file on the disc.) After entering your choice, press the CR/ENTER key.

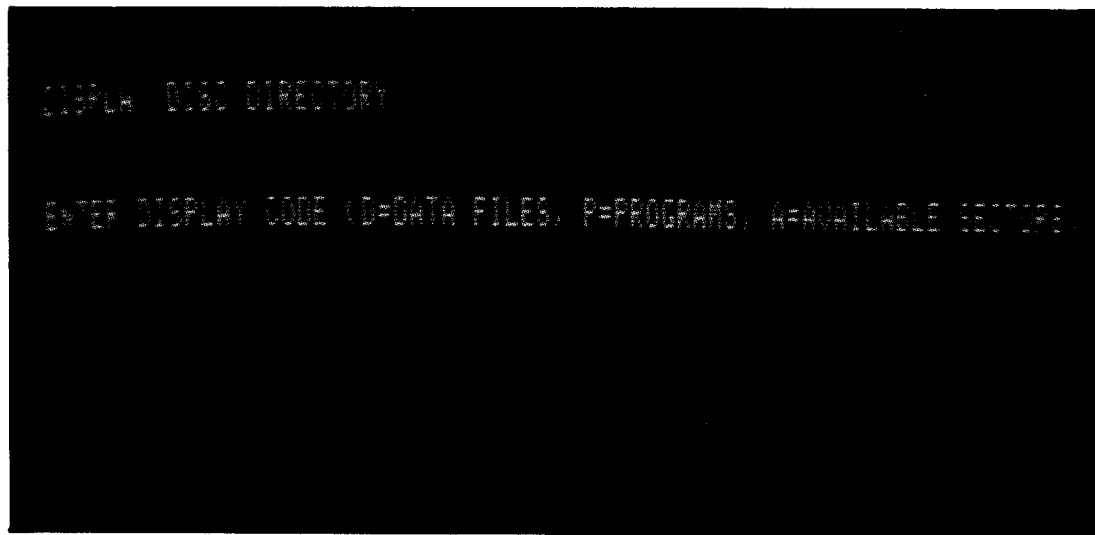

Figure 25. Display disc directory, utility *L

What happens?

The directory listing can be sorted in one of two sequences. The system asks you which of the two you want (Figure 26):

- Location--**Type L** to have the listing sorted by numerical order of items on the disc (Figure 27).
- Unsorted--**Type U** to have the listing displayed without being sorted.

Your Response?

After entering your choice, press the CR/ENTER key.

What happens?

The computer sorts all items you selected according to the sequence you selected (L or U). The VDT then displays a continuous listing on the screen, stopping each time the screen fills. Press CR/ENTER to continue the listing. The VDT display stops when the listing is complete. Press any control key to end the program.

```

DISPLAY DISC DIRECTORY

ENTER DISPLAY CODE (D=DATA FILES, P=PROGRAMS, A=AVAILABLE SECTORS, L=
LOCATION OR UNSORTED SEQUENCE? L/O: L

```

Figure 26. Choosing sequence of listing: by location

```

DISC: 0 940129
FILE FILE FIRST LAST TOTAL NO. OF BYTES/ KEY AVAIL
NAME TYPE SECTOR SECTOR SECTORS RECORDS RECORD SIZE RECORDS
#SRCFL IND 37 61 25 200 128
#BIIIC IND 62 103 42 168 256
#SB8II IND 104 145 42 168 256
SL002 DIR 168 176 9 100 47 22 94
#00F IND 668 673 6 6 1024
#ERR0R DIR 724 861 138 400 330 11 399
#GFL DIR 988 1139 152 99 1551 6 81
#EXUTL DIR 1169 1267 99 64 1551 8 4
#UTIL# IND 1316 1322 7 100 64
. 2 IND 1326 1337 12 48 256
.BASS2 IND 1338 1341 4 50 75
.BLINE IND 1352 1354 3 24 128
.CPU IND 1355 1367 13 100 128
.#MEM IND 1368 1380 13 100 128
.#MEM16 IND 1381 1393 13 100 128
EXBASS DIR 1438 1515 78 50 1551 6 9
TLBASS IND 1517 1551 35 468 75
#BCNFL IND 4501 4501 1 1 1
CR TO CONTINUE, NB TO END

```

Figure 27. Directory listing displayed continuously

DISPLAY FILE INFORMATION ON VDT--*F

To view specific file information on the VDT, you must choose utility program *F (Figure 28):

1. Type on the VDT keyboard: **RUN "*"F"**.
2. Press the CR/ENTER key.

What happens?

The VDT screen displays the following message asking you for information identifying the file you want to view.

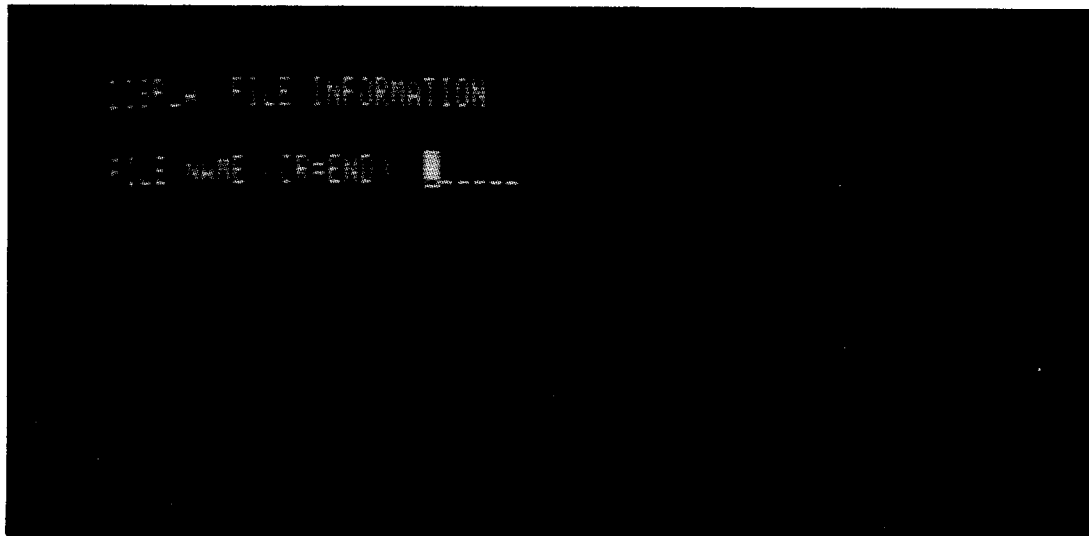

Figure 28. Display file information, utility *F

Your response

Enter the file name and other identifying information. Then press CR/ENTER. (Figure 29)

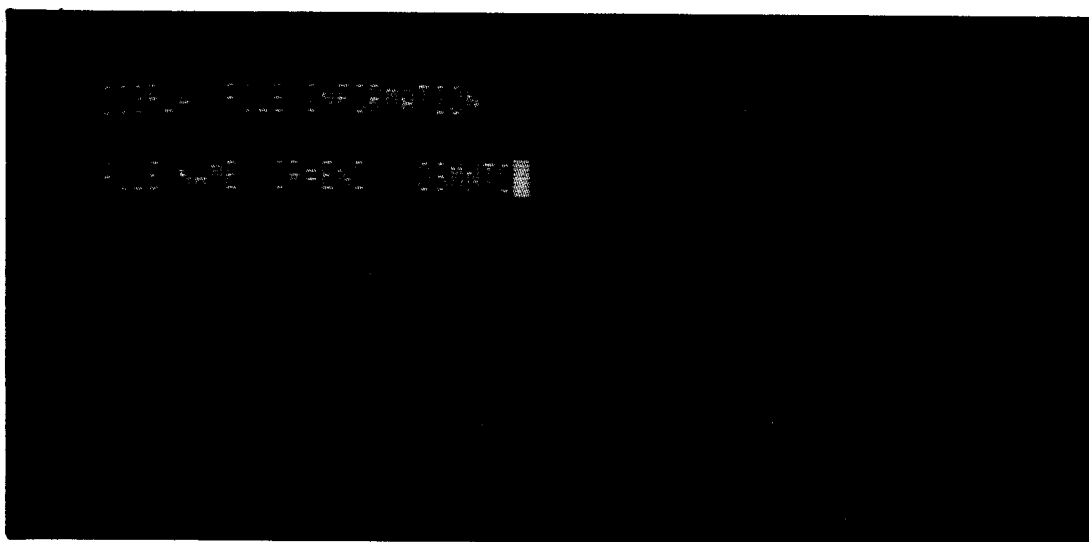

Figure 29. Identifying file needed

What happens?

The VDT displays the file information requested (Figure 30).

```
DISPLAY FILE INFORMATION
FILE NAME (CR-END): DSMNTC

FILE IS      PROGRAM
FIRST SECTOR 146
LAST SECTOR  146
TOTAL SECTORS 1
NO OF RECORDS 1
BYTES/RECORD 1024
PROGRAM SIZE 230
PROGRAM PAGES 1
PROGRAM ID   "DSMNTC*SPECIALTAPECARTRIGEDSOSMON

HARD COPY (Y/CR)? █
```

Figure 30. File information displayed

Your response

Press CR/ENTER to continue. When the file is completed, the listing stops. Again press CR/ENTER. You are now finished with program *F.

What happens?

The VDT displays this message: READY

IMPORTANCE OF BACKUP

BACKUP procedures are performed as a safety precaution. You'll duplicate, or back up, the information about each day's business activities from the disc onto a magnetic tape cartridge. The reasons for this precaution are many: data may be lost through fire, theft, hardware failure, a new program that did not function correctly, or even an operator error. If a problem occurs that results in destruction of information on the disc, you can restore that same information from the backup tape and continue processing.

TERMS YOU SHOULD KNOW

Backup

Backup refers to the method by which the information maintained on a computer system (on the disc) is duplicated and stored separately from the computer (Figure 31).

Restore

Restore refers to the method by which the duplicated backup information is loaded from the tape cartridge back onto the disc. This operation is necessary only if you have had a problem with data on the disc, as noted above. Contact your Customer Service Representative (410 users contact programmer) for help if for any reason you need to restore data from your backup tape cartridges onto the disc.

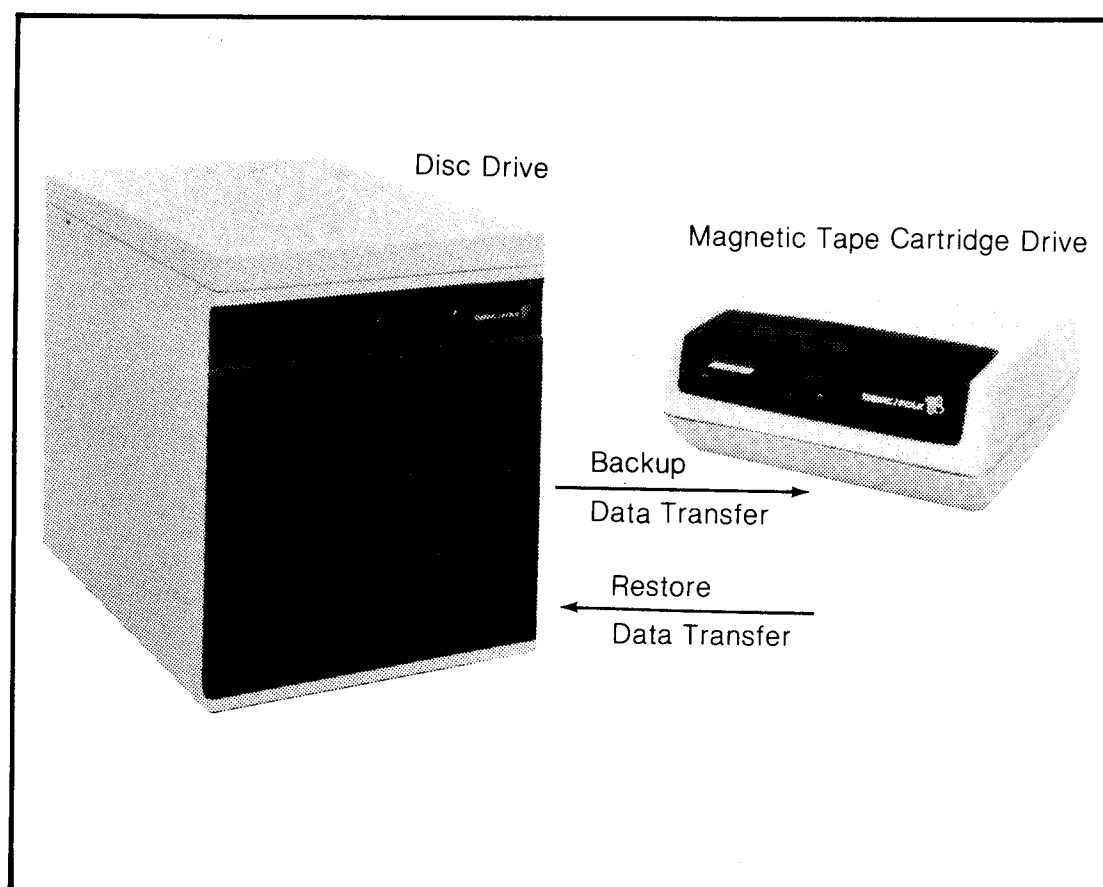

Figure 31. Backup and restore

TWO OPERATING SYSTEMS

Basic Operating System Software (BOSS)

Alternate operating system used for backup

Basic Four computers have two operating systems: the Basic Operating System Software and the Alternate Operating System.

The Basic Operating System Software, or BOSS, is used during normal system operations for running the application programs that direct your data processing activities (Figure 32).

The Alternate Operating System is used in backing up data from disc to tape. The procedures for loading this system and for backing up your data are described in this section (Figure 32).

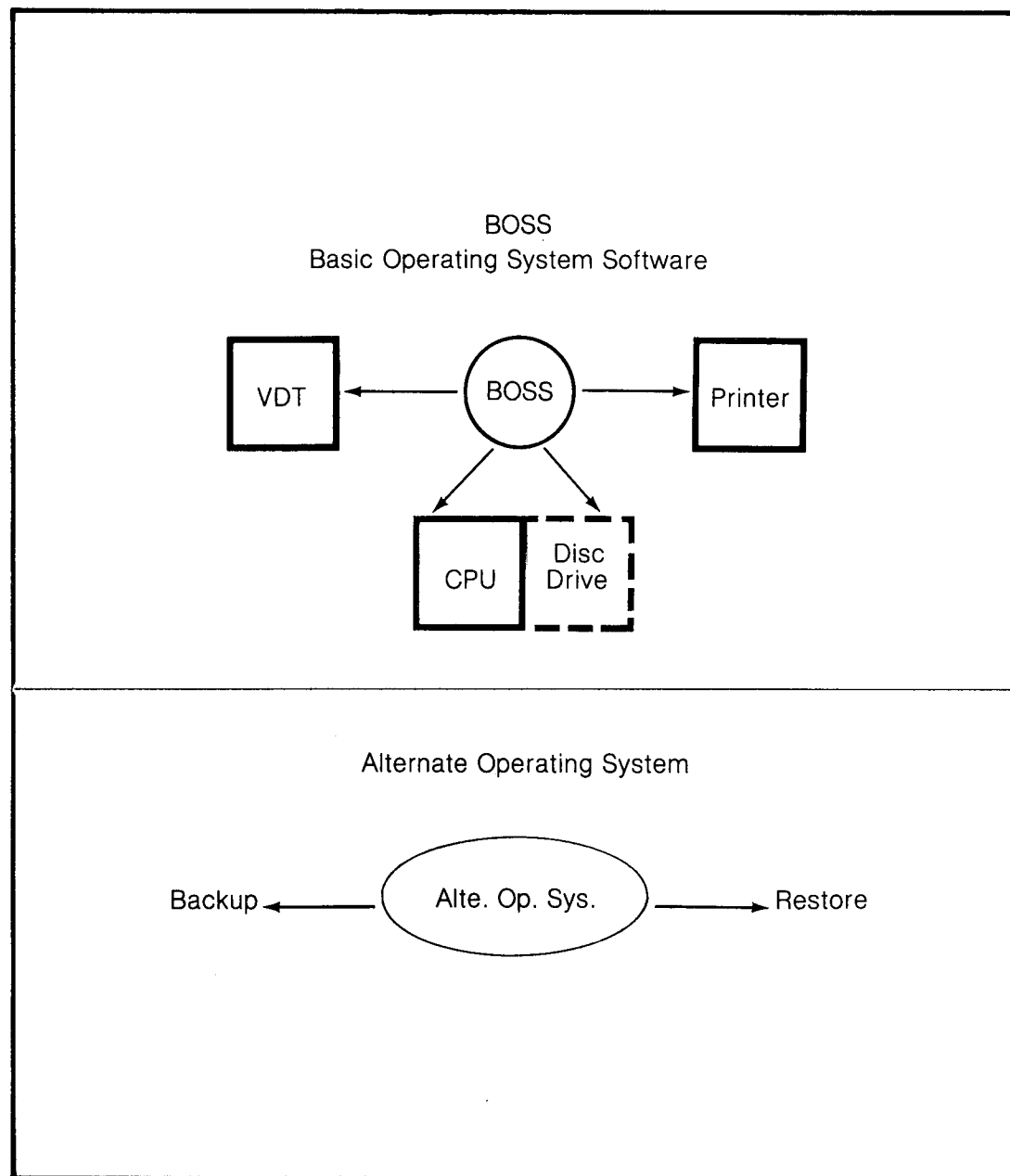

Figure 32. Two operating systems

**BEGINNING BACKUP
PROCEDURE**

The system must be operational, with power on, in order for you to back up your files.

Video display terminal

Turn on the video display terminal power switch below the right front corner of the screen. The cursor appears in the upper left corner of the screen after about 20 seconds.

Central processing unit

Turn on the central processing unit by touching the POWER switch lightly.

Tape cartridge drive

Turn on the tape cartridge drive by flipping up the power switch on the back of the unit.

Preparing tape cartridge

Before inserting a tape cartridge into the drive unit, turn OFF the safe key on the cartridge. Use a thin coin or screwdriver to turn the arrow on the plastic key away from the word SAFE. You can only back up data onto tape if the safe key is turned off.

Inserting tape cartridge

After you turn off the safe key, insert cartridge into the tape drive unit. The tape will automatically rewind, advance briefly, and stop.

**COMMUNICATING WITH
THE COMPUTER DURING
BACKUP**

As part of the normal question-response sequence, the computer may offer you a choice of options, one of which is 'CR' to instruct the computer to act on the response you have just entered. If you do not want to rewind the tape, press 'CR' only. The computer will respond as if to a "no."

DO YOU WISH TO RETENSION THE TAPE? (Y/'CR')

Ending your response with 'CR'

If you want to rewind the tape, select Y for "yes" and also press 'CR' to instruct the computer to act on the response you have just entered. If you do not want to rewind the tape, press 'CR' only. The computer will respond as if to a "no."

BACKUP FILES

You've finished your first day's processing and have backed up your data onto a blank tape cartridge. This backup file is referred to as the SON file. All input sheets and/or transaction journals should be stored with this tape in a safe area away from the computer (Figure 33).

Son-Father files

After you finish the second day's processing, back up that day's information onto another tape cartridge. Refer to this new tape as the SON file. And yesterday's tape? Refer to that one as the FATHER file.

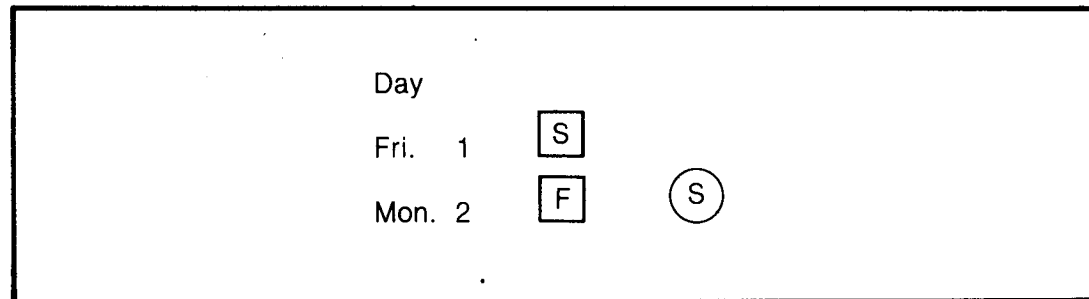

Figure 33. Backup files: son – father concept

Reusing tape cartridge

At the end of the third day's processing, simply reuse the tape cartridge from the first day. Enter your third day's information to make a new SON file. The second day's file now becomes the new FATHER file. This sequence continues, always ensuring two complete sets of backup information (Figure 34).

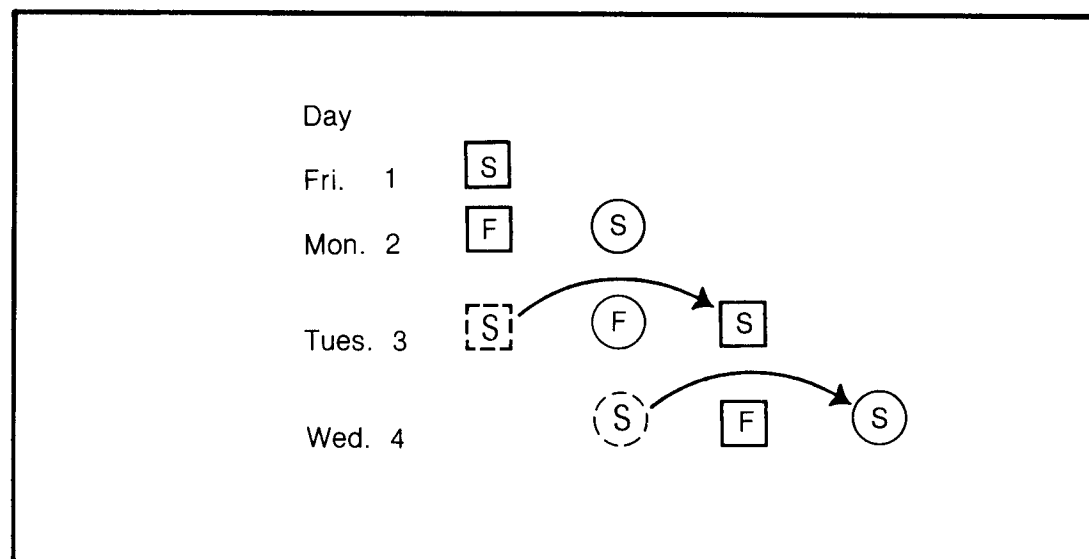

Figure 34. Two sets of backup files

Daily backup files

Information on the computer should be backed up on a daily basis. The main reason is to keep your information safe from day to day; for example, the inventory master file that is updated daily should be backed up daily. Another reason for daily backup is to prevent the workload that would occur if you waited to duplicate a week's worth of information at one time.

Extra protection

You may even want to maintain multiple generations of backup tape cartridges so that the last week (or period) and the last month end are available in addition to the current data. Color-coded backups are common in computer installations as they are easily identified by operators; the tape cartridge can then be stored with similarly identified paperwork files supporting the data.

Backup storage

Backup tape cartridges are normally kept in an area removed from the computer room, preferably in a fireproof safe or cabinet.

Dust-proof container

When the tape cartridge is not in use, protect it against dust by storing in the plastic dust-proof container and special cardboard container that come with the cartridge.

Extra dust protection

A hinged plastic door on the tape cartridge drive unit gives additional protection against contamination of the tape cartridge. When you remove the cartridge from the drive unit, the plastic door closes, preventing dust from entering the tape head/tape operation area.

**BACKING UP INFORMATION
FROM DISC TO TAPE
CARTRIDGE**

The procedures used to back up information from disc to tape cartridge are listed in the following table.

BASIC OPERATING PROCEDURES

COMPUTER DISPLAY OR PROMPT	YOUR ACTION	EXPLANATION
		The first step is to make sure the central processing unit POWER and DISC READY switches are on and the tape cartridge drive power is on.
	On the CPU, press and hold TEST and LOAD switches until ALT / L O A D message appears on VDT screen.	To begin the backup procedure, you need to load the Alternate Operating System.
BASIC FOUR CORPORATION THE OPERATING SYSTEM..... ALT/LOAD INITIALIZATION MAKE ENTRY TO OVERRIDE DEFAULT	'CR'	The ALT/LOAD message begins with the Basic Four Corporation proprietary message, then instructs you to "make entry." You will have 20 SECONDS to respond by pressing the carriage return, or 'CR' key, on the VDT keyboard. (Message not shown in entirety.)
CANNOT FIND ALT/LOAD PLEASE RELOAD	Press and hold TEST and LOAD switches. When A L T / L O A D message appears, press 'CR' quickly.	The system will display this message only if you do not press 'CR' within 20 seconds after the ALT/LOAD message first appears. Simply repeat the loading procedure described above.
ENTER PROGRAM NAME	BBIITC 'CR'	CAUTION <i>You must type this correctly. Any entry other than BBIITC may result in possible damage to your files. (You cannot correct a wrong entry, but can repeat the Alternate Operating System loading procedure.)</i>

Table 1. Backup procedures

COMPUTER DISPLAY OR PROMPT	YOUR ACTION	EXPLANATION
ENTER PGM NAME (*MTC or BASS)	*MTC 'CR'	Enter *MTC (for magnetic tape cartridge) and press 'CR' to cause the main menu selector to appear on the screen. (BASS is a diagnostic program used only by service personnel.)
PLEASE SELECT AN OPTION: 1. FULL BACKUP 2. SELECTIVE BACKUP 3. FULL RESTORE 4. SELECTIVE RESTORE 5. DIRECTORY RESTORE 6. INSTALL SYSTEM 7. UPDATE SYSTEM		Menu of available backup/restore options appears. You will normally use only option number 2, Selective Backup. If you occasionally need to use option 4, Selective Restore, ask your Customer Service Representative for information. CAUTION <i>The other options listed are to be used by service personnel only.</i>
ENTER AN OPTION NUMBER	2 'CR'	Enter option 2, Selective Backup.
DISC NO?	0 'CR'	Enter 0 (zero). This refers to the disc in the computer system.
OK? (Y/'CR') PLEASE WAIT	Y 'CR'	Respond Y for yes, then 'CR'.
LOAD TAPE CARTRIDGE		If you have not already inserted a tape cartridge into the tape drive unit, the system will now ask you to do so. Remember to turn off the safety lock. If the tape cartridge is inserted already, the system will proceed to the next question.
DO YOU WISH TO RETENSION THE TAPE? (Y/'CR')	Y 'CR'	The Y (yes) response tells the system to rewind the tape. This process takes about 2 minutes; it allows for temperature stabilization and ensures proper tension, particularly important for a new tape.
	'CR'	If not rewinding the tape, press 'CR'.

Table 1 Continued

BACKUP PROCEDURES

COMPUTER DISPLAY OR PROMPT	YOUR ACTION	EXPLANATION
DO YOU WANT TO BACKUP PROGRAMS, DATA, OR BOTH? (P/D/B):	D 'CR'	Enter D (and 'CR') for backup of data only. Ordinarily only your Customer (or Sorbus) Service Representative will use the P (for Program) and B (for both) options.
*MTC WILL BACKUP DATA FILES ONLY		
NOW BACKING UP LOADER NOW BACKING UP DIRECTORY		Two messages will display, the second overlying the first.
BACKUP A RANGE OF FILES, OR ENTER THE NAMES OF SELECTED FILES? (R/S/'CR' TO END)	R 'CR'	Since backup is a method of protecting your files, you'll generally choose R for a range of files (instead of just selected files). Your Customer (or Sorbus) Service Representative may instruct you otherwise.
ENTER THE NAME OF THE FIRST FILE TO BE BACKED UP OR 'CR' TO START WITH THE FIRST FILE IN THE DIRECTORY	BGNFL 'CR'	Enter the name of the first file, "BGNFL" (beginning file). Specific file names may be provided by your software vendor for the purpose of backup.
ENTER THE NAME OF THE LAST FILE TO BE BACKED UP OR 'CR' TO FINISH WITH THE LAST FILE IN THE DIRECTORY	'CR'	Press 'CR' to end with the last file in the directory. Be sure that the file names you enter are the first and last in the desired group. If you enter an invalid file name, the computer will ask you for another input.
NOW BACKING UP file name (Beginning Sector - Ending Sector) Current Sector		The backup procedure begins. As each file is backed up, the file name and its beginning and ending sector numbers (location on the disc) will be displayed. If you chose backup of only Programs or only Data files, all other files will be listed as "NOW SKIPPING file name (DUE TO FILE TYPE)".
BACKUP SUCCESSFULLY COMPLETED. PRESS 'CR'	'CR'	Only press 'CR' at this point. Do not remove the tape cartridge yet.

Table 1 (continued)

COMPUTER DISPLAY OR PROMPT	YOUR ACTION	EXPLANATION
TAPE BEING WOUND TO THE END. PLEASE WAIT.		When the tape has been wound to the end, the main selector menu will return to the screen.
PLEASE SELECT AN OPTION: 1. FULL BACKUP 2. SELECTIVE BACKUP 3. FULL RESTORE 4. SELECTIVE RESTORE 5. DIRECTORY RESTORE 6. INSTALL SYSTEM 7. UPDATE SYSTEM		The main menu reappears. At this time your backup procedure is finished, and you won't need to select any options from the menu.
		Remove tape cartridge from the tape drive unit. Label the tape with the contents, date, time, and volume number. Return safety lock to SAFE position.
		Reload regular operating system (BOSS) by pressing LOAD switch on the CPU.

Table 1.

ERROR CONDITION

During backup a hardware failure may occasionally occur, or the disc or tape may be damaged. The computer will alert you to the condition by displaying an error message on the VDT screen. Certain error situations should be handled only by your Customer (or Sorbus) Service Representative, as listed below.

Disc Error--call Customer Service Representative

An example of a disc error follows: please call your CSR rather than attempt to correct this condition yourself. (410 users: please call your programmer.) (Table 2)

COMPUTER DISPLAY OR PROMPT	YOUR RESPONSE	EXPLANATION
<p>NOW BACKING UP FSG01 (3909-3962) 3937</p> <p>FSG01 WILL NOT BE BACKED UP BECAUSE OF DISC ERRORS. PRESS 'CR' TO CONTINUE</p>	<p>'CR'</p>	<p>Normal backup is in progress. The numbers identify the file and location on the disc.</p> <p>DO NOT DO ANYTHING! Contact your Customer (or Sorbus) Service Representative and explain the situation. If your CSR is not available and processing must be continued, write down the information found in the statement immediately above the error message:</p> <p>FILE NAME BEGINNING AND ENDING SECTOR NUMBERS SECTOR NUMBER WHERE ERROR OCCURRED (current sector)</p> <p>In this example, the file name where the error occurred is "FSG01." The file's beginning sector is 3909, and the ending sector is 3962. The sector where the error occurred is 3937.</p> <p>After you write down the information needed to help your CSR analyze the problem, you can continue by pressing 'CR'. The backup process will continue with the next file.</p>

Table 2. Disc error

GENERAL ERROR CONDITIONS The situations described below can usually be corrected by the System 200/410 operator. If preliminary steps do not correct the error, contact your Customer (or Sorbus) Service Representative for help.

COMPUTER DISPLAY OR PROMPT	EXPLANATION
CANNOT FIND file name PLEASE RELOAD	This message arises during initial operation when you are asked to enter a program name (BBITC) and the name that you enter is not valid. Be aware that even a backspace over an erroneous letter will make the name invalid to the system. If this message is displayed, you must perform the alternate load sequence again.
ERROR 17 PRESS 'CR'	This message arises when you have specified an invalid disc number. (On the System 200/410 the only valid disc number is 0 zero). Press 'CR' to return the system to the main menu that lists available backup/restore options.
file name WILL NOT BE FULLY BACKED UP BECAUSE OF DISC ERRORS. PRESS 'CR' TO CONTINUE	<p>This message is displayed during backup procedures when the system cannot read the disc. Generally the message indicates an ERROR 3, which may mean damage, misalignment, or faulty data. Please note the file name, then press 'CR' to allow the backup procedure to continue, skipping the file that generated the error message.</p> <p>Then attempt to load or access the file again. If an ERROR 3 message is generated, try to restore the file from another tape cartridge (if available) with help from your Customer (or Sorbus) Service Representative. If another error is generated or there is no file backup, call your CSR; the disc alignment may need to be checked.</p> <p style="text-align: center;">CAUTION A restore operation will not reflect these disc errors.</p>
Runaway tape (no actual screen message)	<p>This situation results when the system searches through an entire track of tape attempting to locate a particular file. This is evident when the screen display stops updating sector numbers during an update or restore, but the tape continues spinning. (On 4-track tapes, do not confuse this with the tape rewind to position at the next track.)</p> <p>An error will result when the tape reaches the end of the track. If this situation occurs, you may try to repeat the operation, or repeat it using a new tape (if possible). Upon further failures, please contact your Customer (or Sorbus) Service Representative.</p>
SSN ERROR	This error results when the serial number on the tape does not match that on the disc. Please be sure that you are using your correct tape cartridge.

Table 3. General error conditions

COMPUTER DISPLAY OR PROMPT	YOUR ACTION	EXPLANATION
TAPE FULL. INSERT A NEW TAPE, THEN PRESS 'CR' TO CONTINUE	'CR'	This message appears if the tape fills up during the backup process. Remove the tape cartridge from the drive unit. Immediately label it with the contents, date, and volume number, and turn the safety lock on. Insert a new tape cartridge into the drive unit (safety lock off). After it rewinds automatically, press 'CR'.
DO YOU WISH TO RETENSION THE TAPE? (Y/CR)	'CR'	Press 'CR' to continue if you don't want to retension the tape.
PLEASE WAIT		After the tape positions itself, the backup process will continue.

Table 4. Tape full condition

HELPFUL HINTS

Selective backup

Keep in mind that even a selective backup will write over any data on the tape cartridge.

Protecting data--restore

To protect data on the tape when restoring, make sure that the arrow on the tape cartridge safety lock is pointing to the word SAFE.

Protecting data--backup

When backing up data, make sure that the arrow on the safety lock points away from the word SAFE, or an ERROR 0 will result

Cartridge requirements

Larger megabyte disc systems may require more than one cartridge for backup. *MTC will ask the operator to change tapes. Be aware that internal (software) tape sequence numbers are assigned and checked during a restore procedure.

Restoring data

When attempting to restore an operating system, make sure that the serial number on the tape matches the number on the disc. If it does not, an "SSN ERROR" will result.

TURNING ON EQUIPMENT*Video display terminal*

- Make sure the VDT is plugged into an electrical outlet. Is there power at the outlet? Turn on the ON-OFF switch.
- Turn the BRIGHTNESS KNOB clockwise as far as it will turn.
- If there's still no response from the VDT, please call your Customer (or Sorbus) Service Representative.

Back Controls: Ordinarily the DUPLEX and RATE controls on the back of the unit are set when the unit is installed for you. These should not be changed. If you are having a problem with the VDT, however, make sure the settings are as follows (Figure 35):

- DUPLEX switch must be in the "F" (full duplex) righthand position for normal operation. (This switch determines the operating mode.)
- RATE switch must be in the "9600" middle position for normal operation. (This switch determines the transmission rate of the VDT.)

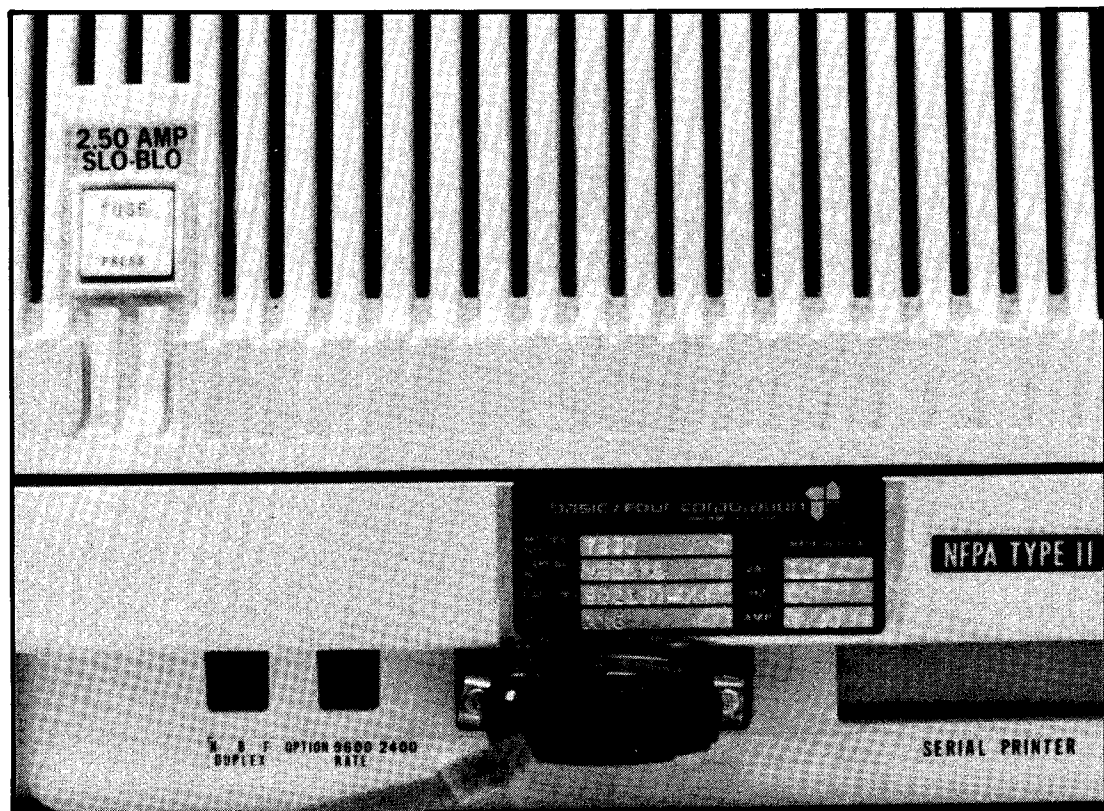

Figure 35. VDT back controls

PROCEDURAL ERRORS

Central processing unit

- Make sure the CPU is plugged into an electrical outlet that is providing power. Press the POWER switch on and listen for the fan in the rear of the unit. If you don't hear the fan, the outlet may be dead.
- If power is being supplied to the CPU, but the green power light is not on, if the green DISC READY and RUN lights are not on, or the VDT screen displays no messages, please call your Customer (or Sorbus) Service Representative.

Magnetic tape cartridge drive unit

- Make sure the tape drive unit is plugged into an electrical outlet that is providing power. Flip the ON-OFF switch to turn the unit on, and listen for the fan motor. If you don't hear the fan, the outlet may be dead.
- If power is being supplied, but the tape drive unit still does not respond, please call your Customer (or Sorbus) Service Representative.

Printer

- Make sure the printer is plugged into an electrical outlet that is providing power. Press the POWER switch to turn the unit on. The printer head should move left-right-left slowly, then quickly. If it does not, press the POWER switch off.
- Wait about 15 seconds, then turn the power on again and wait for the printer head to move. If the printer still doesn't respond, call your Customer (or Sorbus) Service Representative.

OTHER ERRORS

If an error occurs in the System 200/410, a message will appear on the VDT screen indicating the program being run, line number where the error occurred, and an error number and/or description.

Your response

Write down the entire error message and call your Customer (or Sorbus) Service Representative.

Serial number locations

If your Customer Service Representative needs to know the serial numbers of your System 200/410 components, these numbers are located on the back of each of the units. Record the numbers on the Service Reference page found in the Attachment to this guide.

**CLEANING VIDEO DISPLAY
TERMINAL***General cleaning*

The VDT is no more difficult to care for than a conventional electric typewriter. Keep it clean; keep its connectors plugged in; and keep its immediate area clear of all food or beverages and of stacked paper, books, and other items that might interfere with free air circulation. Pay particular attention to the display screen, where any residual dirt film will later block the character display, and to the keytops on the keyboard, which receive the largest deposit of dirt.

Dust

Wipe or brush off dust, lint, and smudges whenever they become noticeable, being careful not to wipe or brush dust into the keyboard through the spaces between and around the keys. For wiping, use a soft, clean dust cloth or commercial lint-free tissue.

Light dirt coating

For stubborn accumulations, dampen the cloth or tissue slightly, but only with plain water or a cleaning fluid suitable (safe) for use on plastic and painted surfaces, such as one of the commercially available antistatic cleaning fluids or with 91% isopropyl alcohol. The cloth or tissue should not be wet, just damp, so that it will pick up dust or dirt readily.

Heavy dirt coating

The occasional light cleaning described above will not always prevent the gradual accumulation of a coating of varnish-like dirt, particularly on the keytops, and a more thorough cleaning will usually be necessary about once a month. For this cleaning, wipe all external surfaces with the antistatic cleaning fluid and use a succession of soft cloths or lint-free tissues. As each cloth becomes dirty, discard it and continue with a clean one. Use enough fluid to moisten each cloth or tissue thoroughly so that very little wiping pressure will be needed, but not enough to allow dripping under the wiping pressure. After cleaning each surface, wipe off the fluid and dissolved dirt with a dry cloth or tissue.

**CLEANING CENTRAL
PROCESSING UNIT***General cleaning*

Keep the immediate work area clear of stacked papers, books, food, and other items that might cause contamination or interfere with free air circulation and prevent proper cooling of the unit.

Dust

Wipe up or brush off dust, lint, and smudges whenever they become noticeable, being careful not to wipe or brush dust into exposed internal areas of the unit. For wiping use a soft clean dust cloth or a lint-free tissue, and be careful not to scratch surfaces by hard rubbing.

Light dirt coating

For stubborn accumulations, dampen the cloth or tissue slightly, but only with plain water or a cleaning fluid suitable (safe) for use on plastic and painted surfaces, such as one of the commercially available antistatic cleaning fluids. The cloth or tissue should not be wet, just damp, so that it will pick up dust or dirt readily.

Heavy dirt coating

The occasional light cleaning described above will not always prevent the gradual accumulation of a coating of varnish-like dirt, and a more thorough cleaning will usually be necessary about once a month, even in the cleanest offices. For this cleaning, wipe all external surfaces with the antistatic cleaning fluid and use a succession of soft cloths or lint-free tissues. As each cloth or tissue becomes dirty, discard it and continue with a clean one. Use enough fluid to moisten each cloth or tissue thoroughly so that very little wiping pressure will be needed, but not enough to allow dripping under the wiping pressure. After cleaning each surface, wipe off the fluid and dissolved dirt with a dry cloth or tissue. Do not try to clean the inside of the CPU.

CLEANING MAGNETIC TAPE CARTRIDGE DRIVE UNIT

General cleaning

Proper and regular maintenance of the tape cartridge unit will assure operation at the high levels of data and mechanical reliability that have been designed into the system. Particularly important are the operator maintenance functions intended to keep the system free of dirt and contaminants. At the high densities of data on tapes written or read, extremely small particles of dust or oxide from the tape can cause data errors. Careful attention to the cleaning procedures described below will assure the greatest possibility of trouble-free operation. Keep the immediate work area clear of stacked papers, books, food, and other items that might cause contamination or interfere with free air circulation and prevent proper cooling of the unit.

Dust

Wipe up or brush off dust, lint, and smudges whenever they become noticeable, being careful not to wipe or brush dust into exposed internal areas of the device. For wiping, use a soft clean dust cloth or a lint-free tissue, and be careful not to scratch surfaces by hard rubbing. Pay particular attention to surfaces where any residual dirt film will first be visible.

Light dirt coating

For stubborn accumulations, dampen the cloth or tissue slightly, but only with plain water or a cleaning fluid suitable (safe) for use on plastic and painted surfaces, such as one of the commercially available antistatic cleaning fluids. The cloth or tissue should not be wet, just damp, so that it will pick up dust or dirt readily.

Heavy dirt coating

The occasional light cleaning described above will not always prevent the gradual accumulation of a coating of varnish-like dirt, and a more thorough cleaning will usually be necessary about once a month, even in the cleanest offices. For this cleaning wipe all surfaces with antistatic cleaning fluid and use a succession of soft cloths or lint-free tissues. As each cloth or tissue becomes dirty, discard it and continue with a clean one. Use enough fluid to moisten each cloth or tissue thoroughly so that very little wiping pressure will be needed, but not

enough to allow dripping under the wiping pressure. After cleaning each surface, wipe off the fluid and dissolved dirt with a dry cloth or tissue.

Quarterly cleaning

Additional cleaning is needed at longer intervals. Every four months, clean the entire surface of the tape drive unit with solvent, making sure you remove accumulation of dust around the hold-down knobs and in the head area. Remove head covers and clean on the inside and outside making sure you remove all deposits of dust and other possible tape contaminants. For any periodic maintenance functions beyond those described here, contact your Customer (or Sorbus) Service Representative.

Magnetic Head

Clean the magnetic head surfaces after every eight hours of system use. Dirty heads may cause data dropouts, during both recording and the reading of the tape. For cleaning, follow the steps below:

Removing tape cartridge

1. Remove tape cartridge from the tape unit.

Removing drive unit cover

2. Remove the unit's cover by pulling it steadily and gently directly away from the front of the unit (Figure 36).

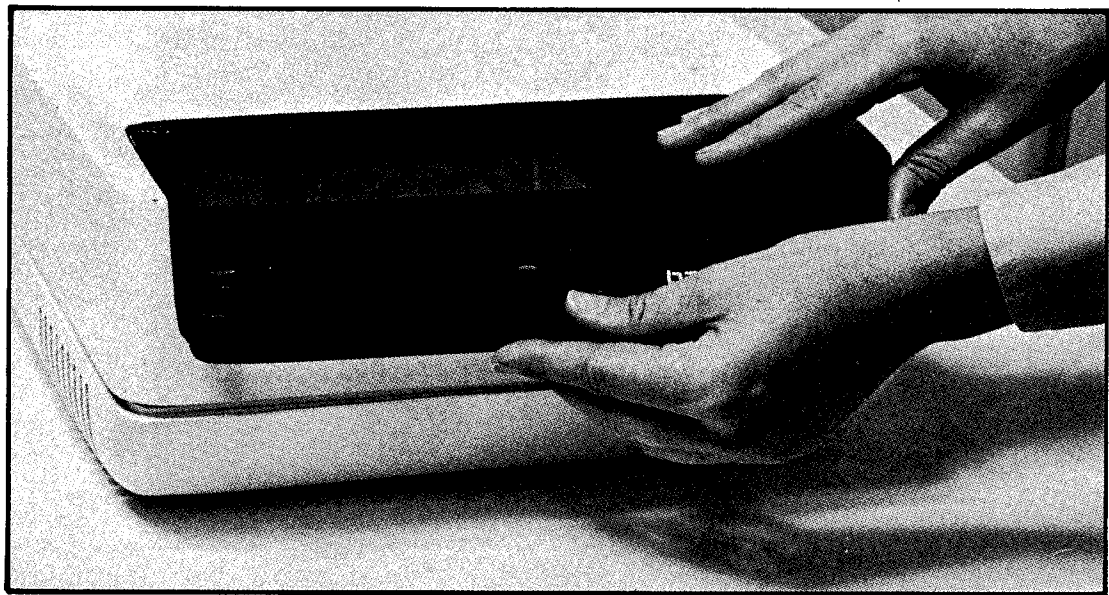

Figure 36. Removing tape drive unit cover

Using cloth and 91% isopropyl alcohol

3. Moisten a clean, soft, lint-free cloth or cotton-tipped swab with head cleaning solution. This should be a nonresidue, noncorrosive cleaning agent such as 91% isopropyl alcohol. Do not get the cleaner on your skin because many solvents may cause irritation, or may have a toxic effect.

CAUTION

Spray-type head cleaners are not recommended because the drive motor is next to the head assembly. Be very careful to avoid contaminating the drive motor lubricant with cleaning solvents.

Head surfaces

4. Clean head surfaces, including the erase head surface. Use a dry, clean, lint-free cloth to remove all cleaner residue and thoroughly dry surfaces (Figure 37).

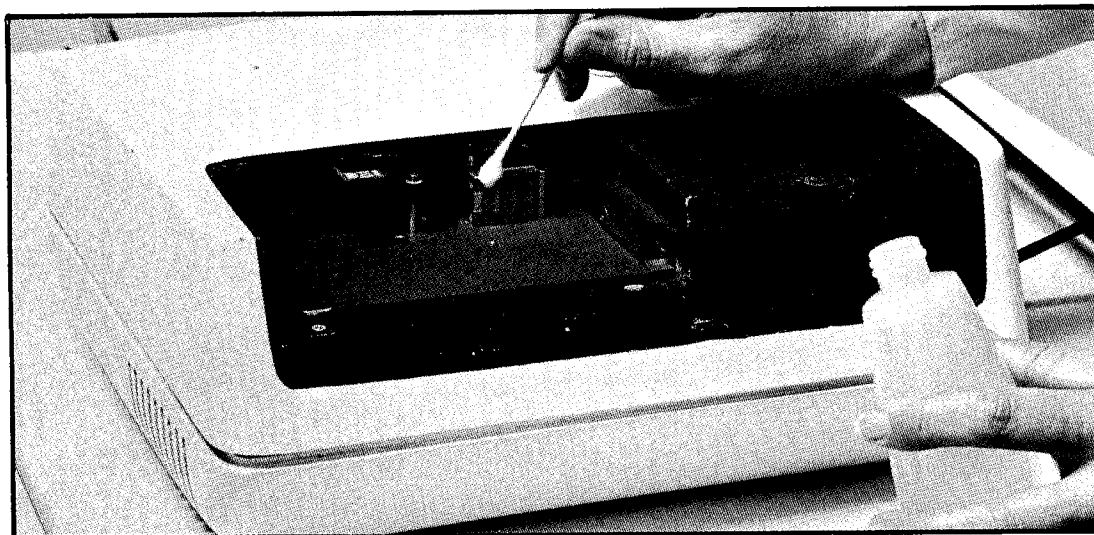

Figure 37. Cleaning head surfaces

Head guides and guide blocks

5. Clean the head guides and head guide blocks with head cleaner. Guide blocks are immediately in back of the guides. Dry all parts with a clean, lint-free cloth (Figure 38).

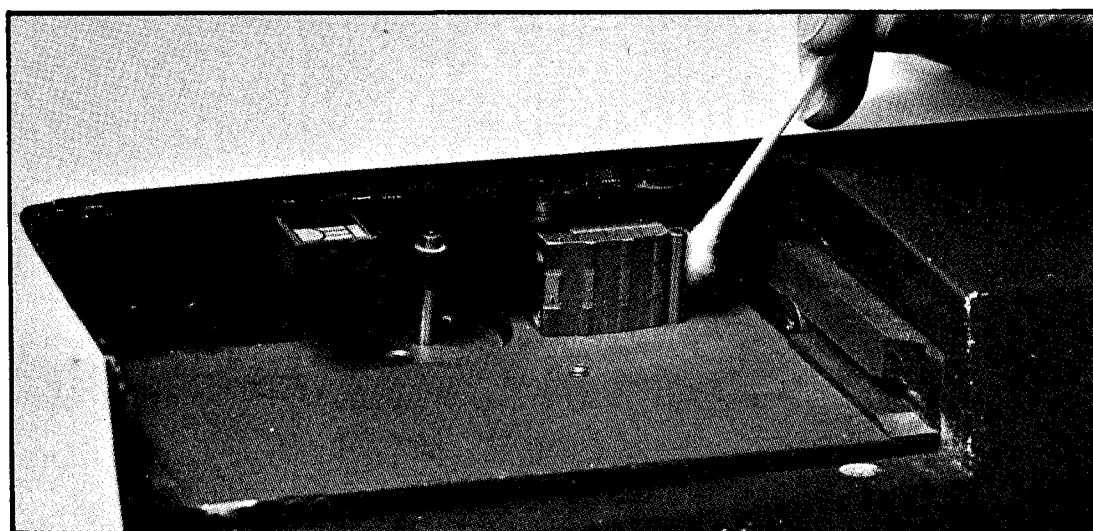

Figure 38. Cleaning head guides

Roller guides

6. Clean the roller guides with head cleaner, rotating them to be sure the complete roller surface is cleaned. Dry with a clean, lint-free cloth.

Motor Capstan

Clean the capstan after every eight hours of use, following this procedure:

Using cloth and 91% isopropyl alcohol

1. Moisten a dry, clean, lint-free cloth or cotton-tipped swab with head cleaning solution (e.g. 91% isopropyl alcohol), being careful not to get any solvent on your skin.

Rotating capstan

2. Rotate the capstan by pressing one of the drive switches (Fig. 39).

Cleaning capstan surface

3. As you rotate the spindle, clean the surface of the capstan with the moistened cloth. Make a visual inspection of the capstan surface for abrasion or polish. If you observe defects, contact your Customer (or Sorbus) Service Representative.

Drying surface thoroughly

4. Dry the capstan surface thoroughly with a dry, clean, and lint-free cloth.

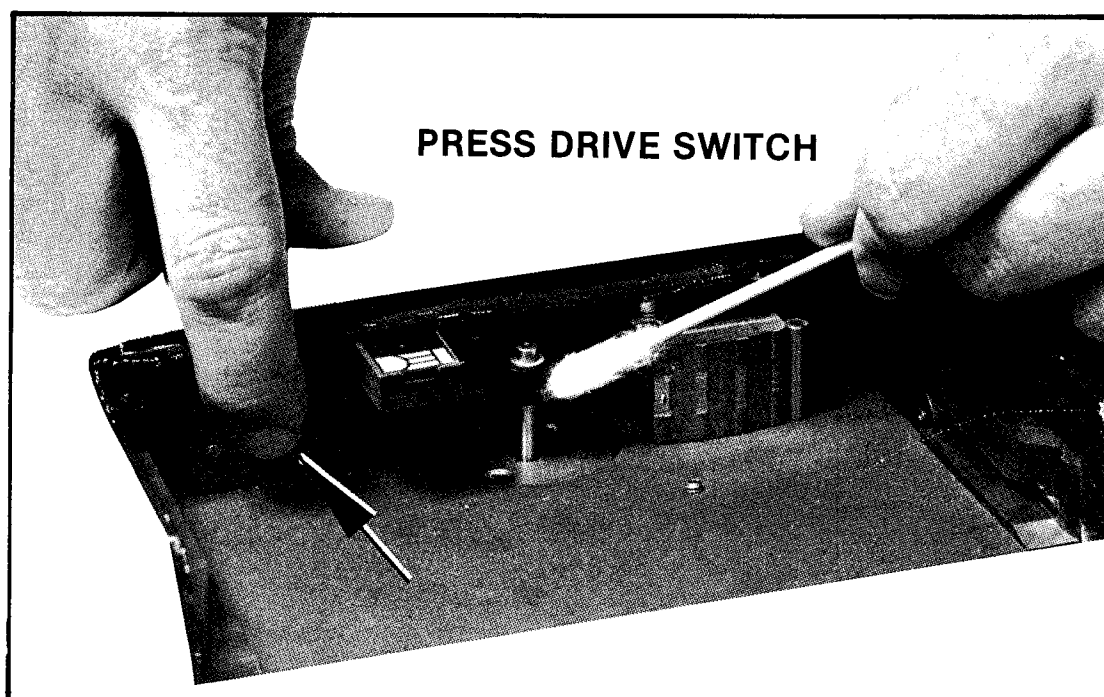

Figure 39. Cleaning motor capstan

Tape drive cover

Replace the tape drive unit cover by aligning the holes in the cover with the mounting pins on the bottom part of the tape drive. Press firmly into place (Figure 40).

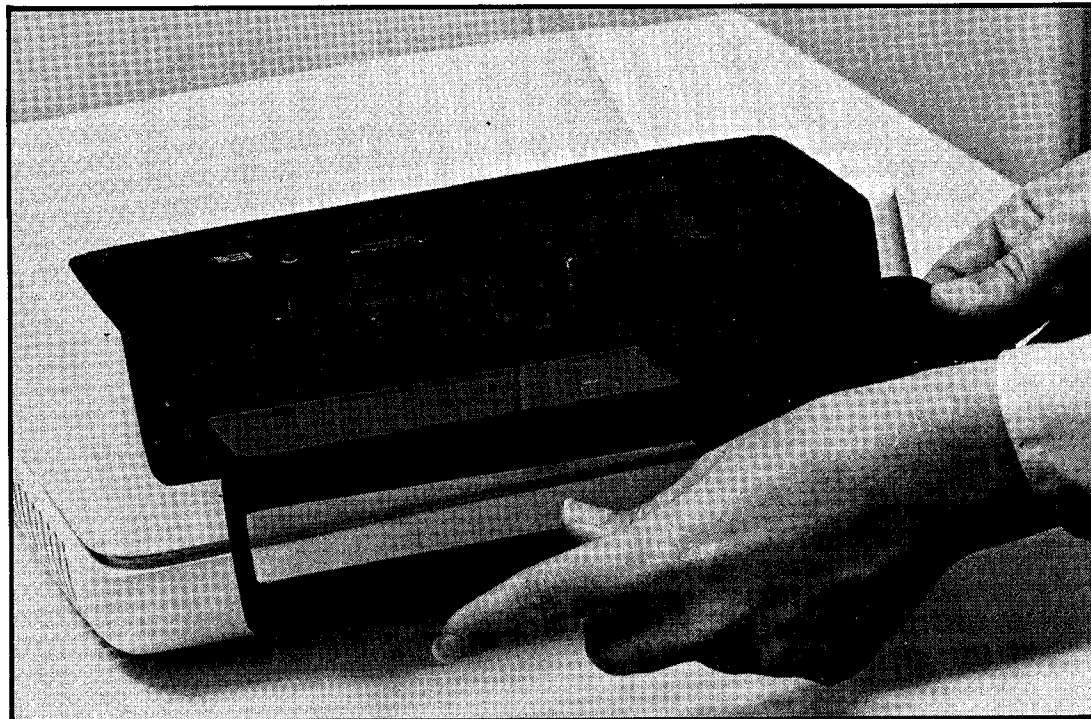

Figure 40. Replacing tape drive unit cover

Optional Tape Cleaner

An optional tape cleaner is available to remove foreign material from the tape before the tape passes the magnetic head. Remove accumulated dirt from the tape cleaner after every 40 hours of use.

Cleaning tape cleaner

1. Clean the face of the tape cleaner using a clean, dry, lint-free cloth or cotton-tipped swab and a cleaning agent such as 91% isopropyl alcohol. Follow the same procedures described in Steps 3 and 4 for cleaning magnetic head surfaces as shown on page 25.
2. Insert a folded sheet of paper in the bottom of the cleaning slot of the cleaner. Slide the paper up, lifting any dirt from the tape cleaner.
3. Use a soft bristle brush and a vacuum cleaner plastic nozzle to remove any foreign material from the area around the tape cleaner and head assembly.

CAUTION

Never use any metal object to clean the tape cleaner. If the tape cleaner should become scratched, it could destroy the oxide coating of tape passing across it.

CLEANING PRINTER*General cleaning*

Keep the immediate work area clear of stacked papers, books, food, and other items that might cause contamination, interfere with the paper supply, or interfere with free air circulation and prevent proper cooling of the unit.

Dust

Wipe or brush off dust, lint, and smudges whenever they become noticeable, being careful not to wipe or brush dust into exposed internal areas of the device. For wiping use a soft clean dust cloth or a lint-free tissue. Be careful not to scratch surfaces by hard rubbing.

Light dirt coating

For stubborn accumulations, dampen the cloth or tissue slightly, but only with plain water or a cleaning fluid suitable (safe) for use on plastic and painted surfaces, such as one of the commercially available antistatic cleaning fluids. The cloth or tissue should not be wet, just damp, so that it will pick up dust or dirt readily.

Heavy dirt coating

The occasional light cleaning described above will not always prevent the gradual accumulation of a coating of varnish-like dirt, and a more thorough cleaning will usually be necessary about once a month, even in the cleanest offices. For this cleaning, wipe all external surfaces with the antistatic cleaning fluid and use a succession of soft cloths or lint-free tissues. As each cloth or tissue becomes dirty, discard it and continue with a clean one. Use enough fluid to moisten each cloth or tissue thoroughly so that very little wiping pressure will be needed, but not enough to allow dripping under the wiping pressure. After cleaning each surface, wipe off the fluid and dissolved dirt with a dry cloth or tissue.

HANDLING PRINTER PAPER**Loading the Paper***Paper supply*

The System 200/410 printer uses continuous pin-feed paper ranging in size from 4" to 15" wide, with 1/2" wide blue horizontal bars. It will print an original and up to five copies (carbon or carbonless). For various paper types, consult your Customer (or Sorbus) Service Representative.

Power on

Make sure the printer POWER switch is on.

On-line switch off

Press the ON-LINE switch off (light goes out).

Loading the paper

Place a stack of paper under the machine in the center of the base. The side to be printed on, with the blue bars, should face you when you lift the top sheet (Figure 41).

Opening printer cover

Open the printer cover by lifting the top portion of the cabinet. There are no locks or latches to be released. Rest the cover in the UP position (Figure 42).

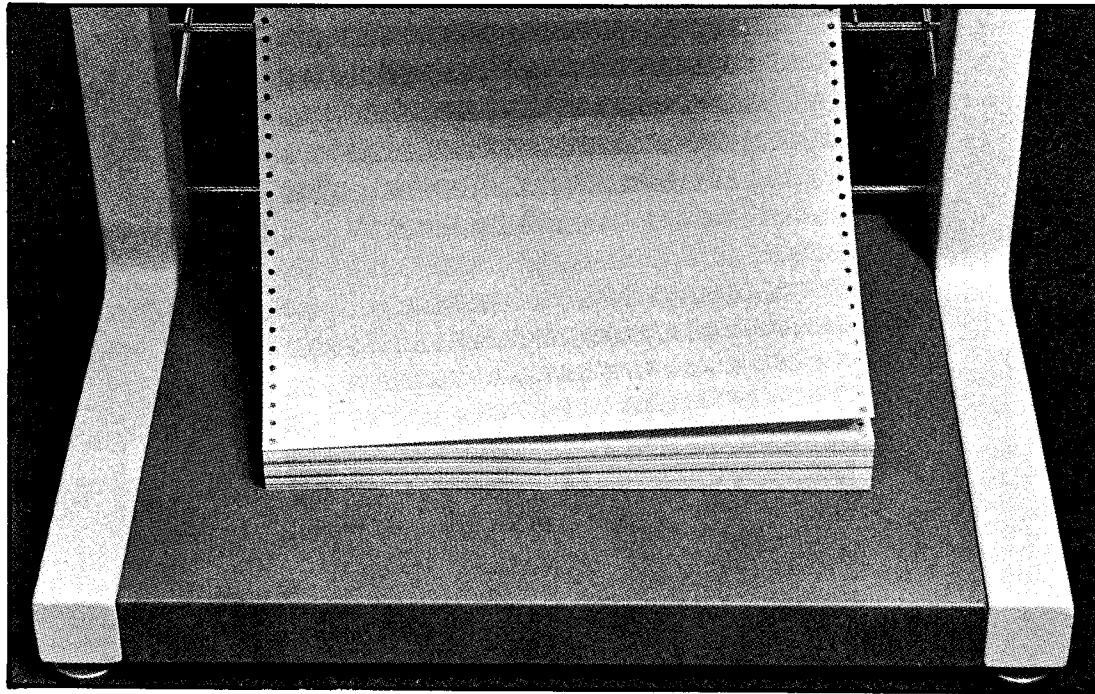

Figure 41. Paper stacked on printer base

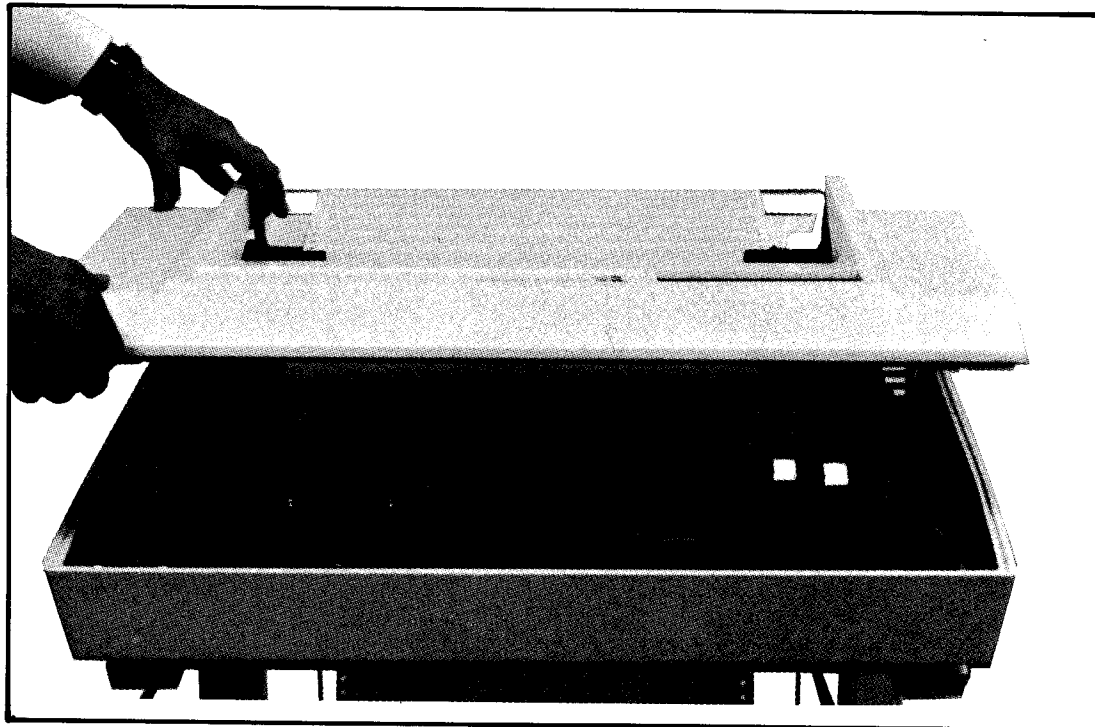

Figure 42. Opening printer cover

Clamps hold the paper

Four hinged clamps, or tractors, hold the paper securely. Two tractors are on top and two on the bottom. Lift these hinged tractors and remove any paper still in the printer (Figure 43).

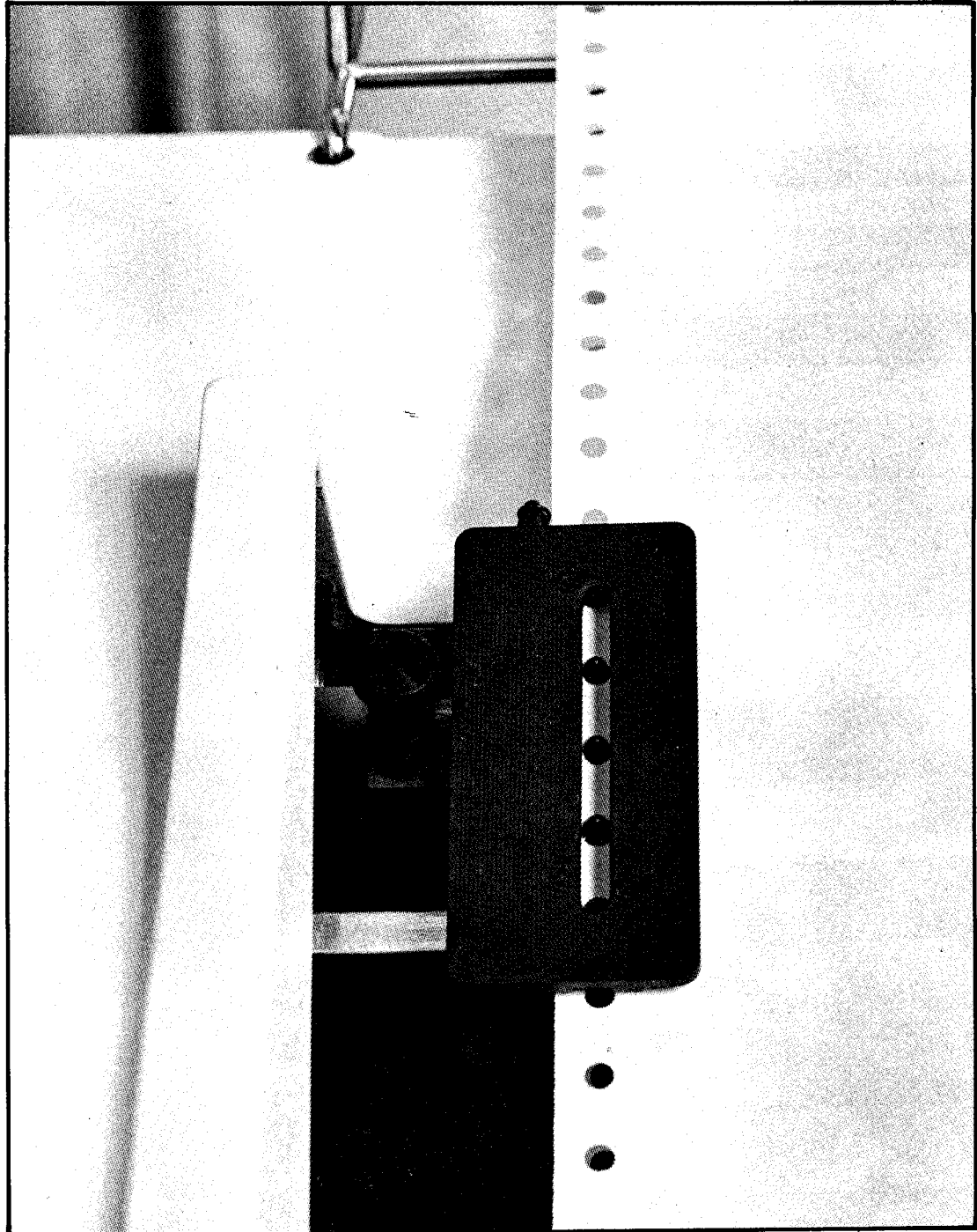

Figure 43. Tractor holding paper in place

Loading paper
Step 1

On the back of the printer, you will find a stainless steel rack. Thread the paper between the rods and under the platen (Figure 44).

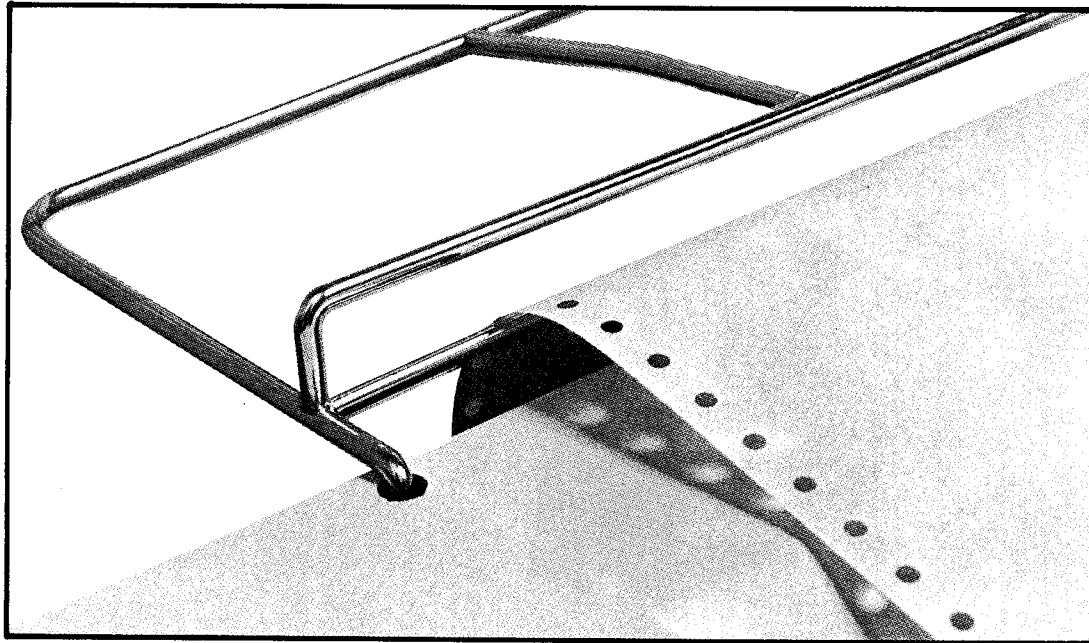

Figure 44. Threading paper between rods 6 and 7

Step 2

Feed the paper under the platen and pull two sheets through so that they lie over the front of the machine (Figure 45).

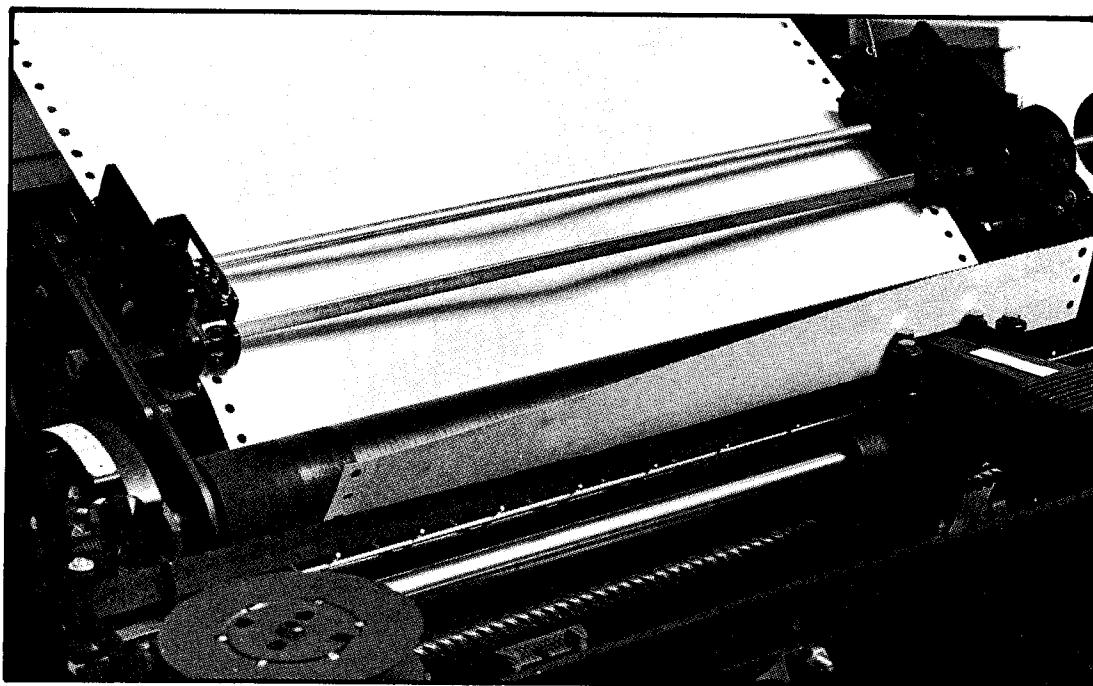

Figure 45. Threading paper under platen

Loading paper
Step 3

Lay the paper back over the top of upper tractors (open). The front of the paper, blue bars showing, should face you (Figure 46).

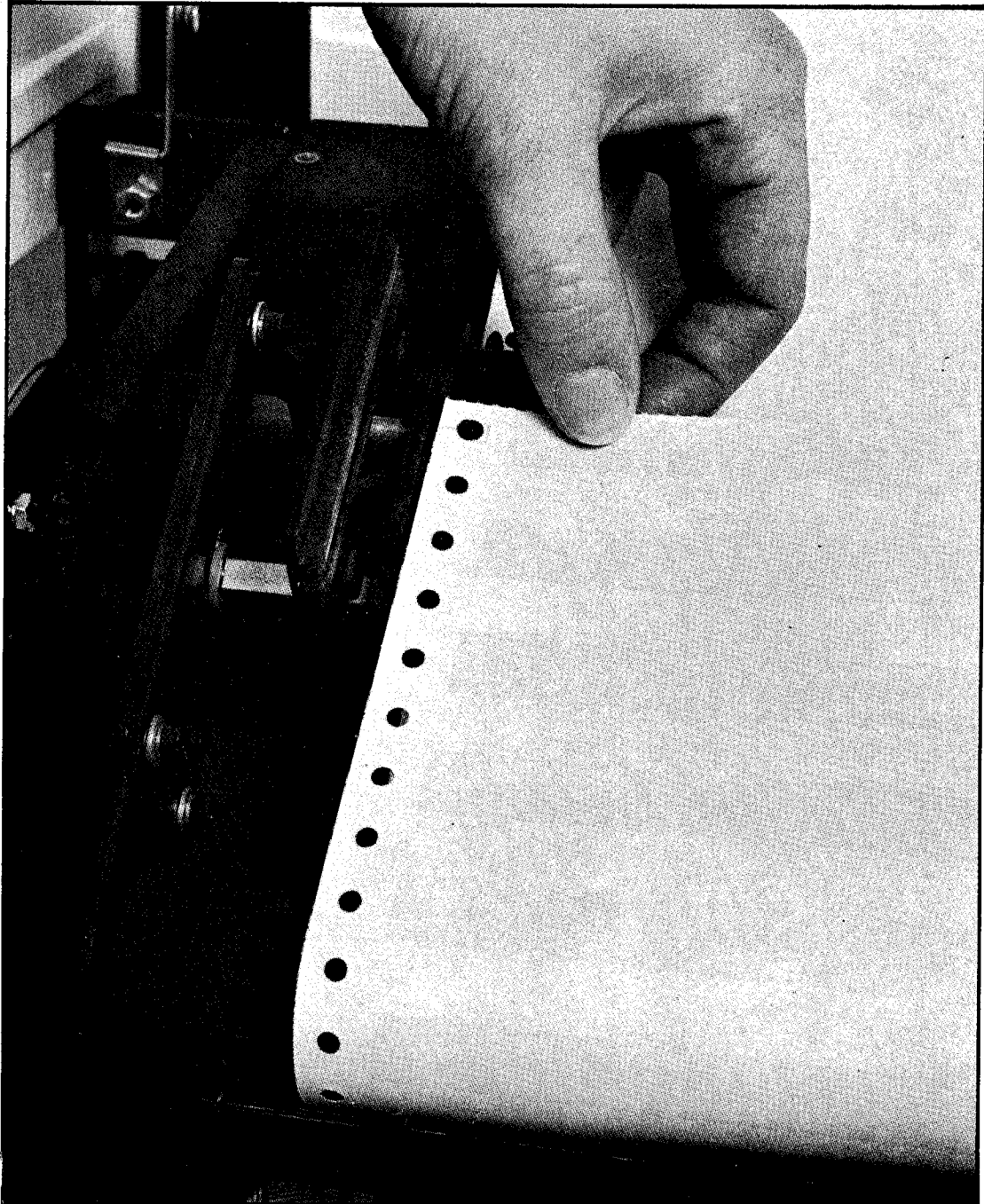

Figure 46. Placing paper holes on opened tractor

Step 4

Align the tractor holes in the paper over upper left tractor and close the tractor cover.

Step 5

Align the tractor holes in the paper over upper right tractor and close the tractor cover. You may have to loosen the thumb screw to adjust it sideways to the paper width (Figures 47 and 48).

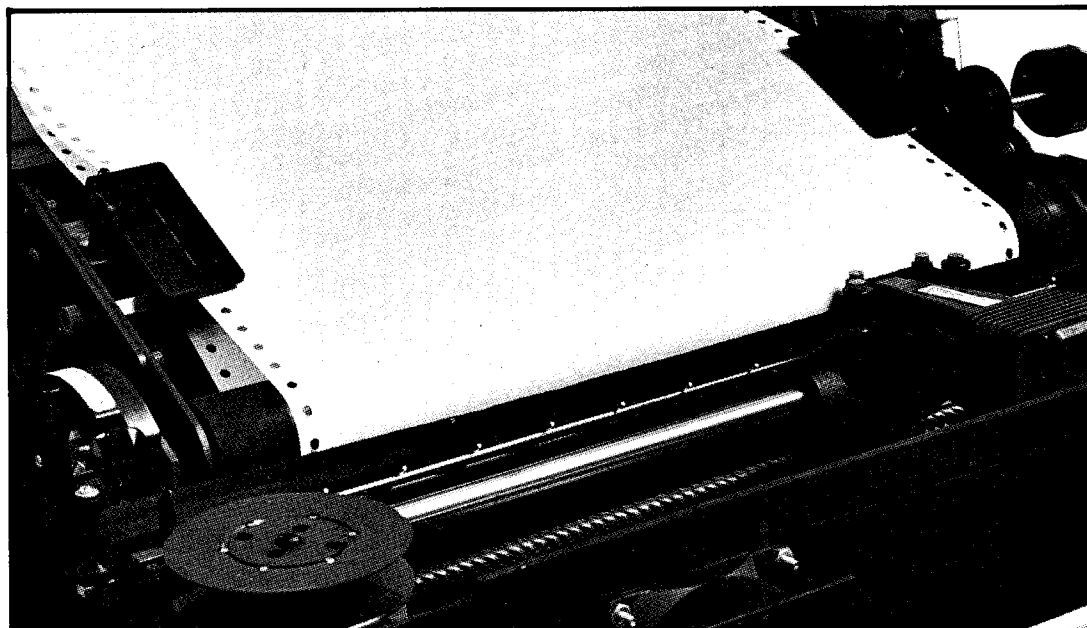

Figure 47. Tractor covers closed

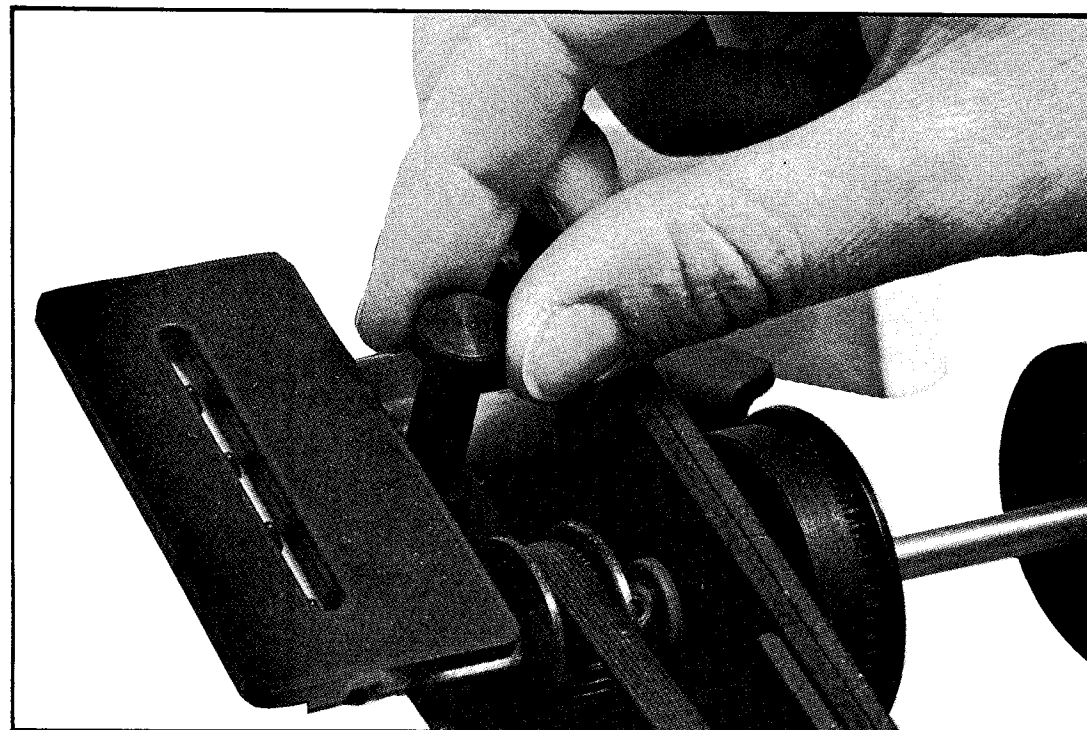

Figure 48. Adjusting for paper width

*Loading paper
Step 6*

Gently pull the paper backwards from behind the platen until the tractor holes line up against the lower tractors. Then close tractor covers.

*Loading paper
Step 7*

Make sure the lines on the paper are horizontally lined up with the same positions on the tractors on each side (Figure 49).

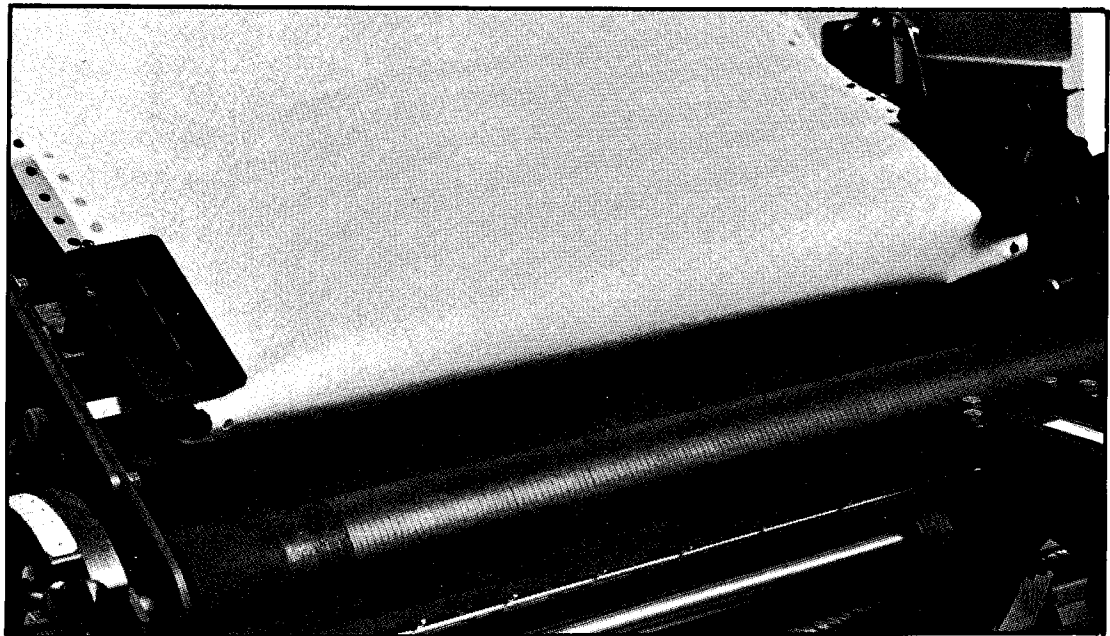

Figure 49. Paper aligned incorrectly

*Loading paper
Step 8*

Place the paper over rod on the rack at the back of the printer (Figure 50).

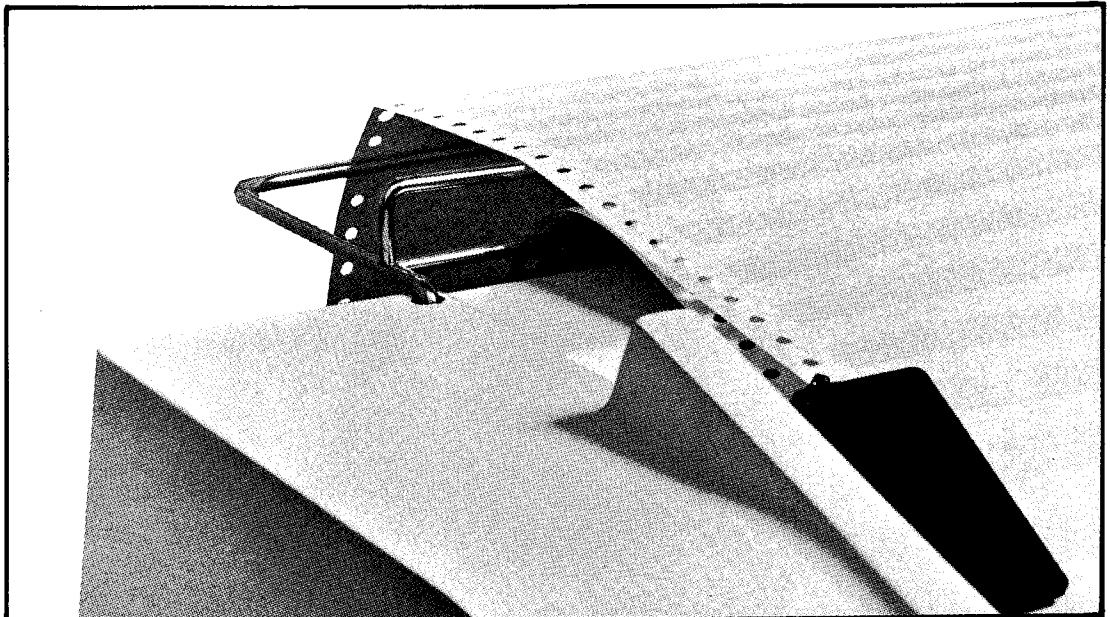

Figure 50. Threading paper back over top rack

Checking paper installation

Close the printer cover. Press the TOP OF FORMS switch to check paper installation. The paper should advance one form at a time without tearing or bunching.

If paper won't advance

If the paper won't advance, you may have left the ON-LINE switch on while loading paper. Simply turn it off now and press the TOP OF FORMS switch again.

Adjusting Paper to Start at Top of New Page

On the continuous paper used by the printer, each section is considered a new form or page. Pages are separated by perforations across the width of the paper.

Power switch activation

Press the POWER switch to activate the READY and TOP OF FORM lights. (The ON-LINE light must be OFF.)

Advancing paper one page

Press the TOP OF FORMS switch to advance paper one page.

Adjusting paper position with platen knob

Adjust paper to the top of a new page by turning the platen knob located to the right of the platen. Make sure that a line of perforations in the paper is aligned with the top of the printer head (Figure 51).

Placing printer on-line again

Press ON-LINE switch on. The printer is ready to use.

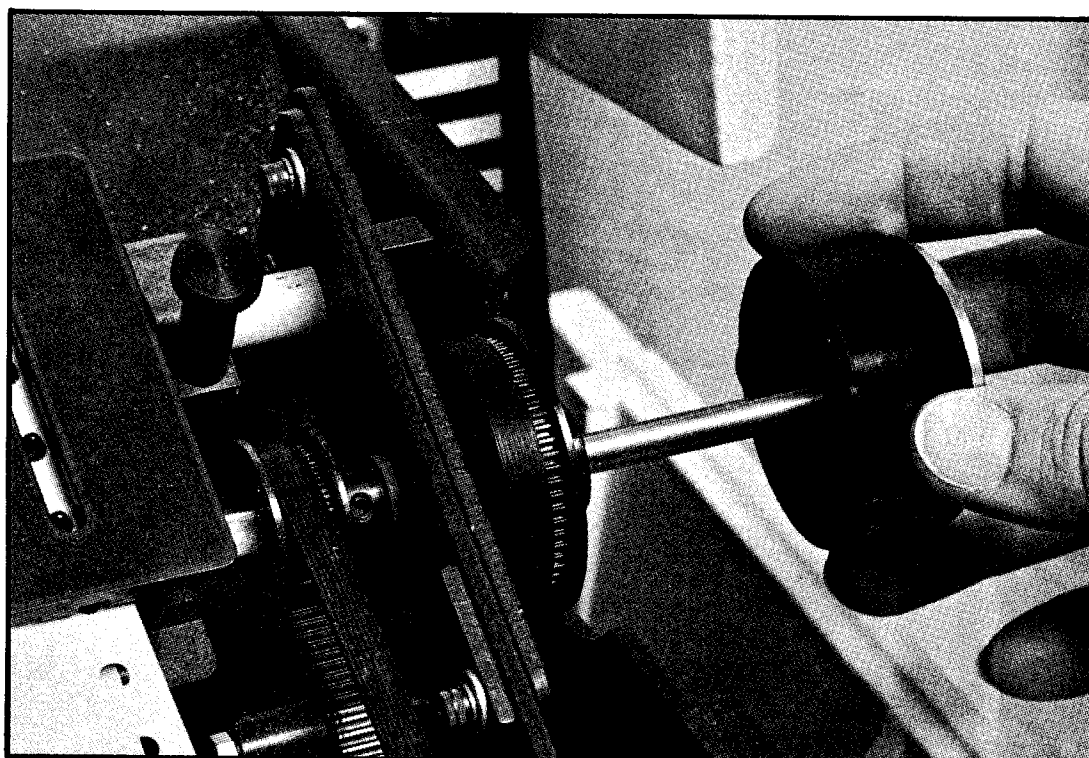

Figure 51. Adjusting paper with platen knob

Reloading Paper During Operation

Check your paper supply on the base of the printer to avoid running out of paper during a printing operation. If the paper supply does run out, however, the following will occur:

1. High-pitched "BEEP" sound occurs and printing stops.
2. FORMS indicator light comes on.
3. ON-LINE indicator light goes out.

Printing the page that was in progress

To finish the page the printer was on when it stopped, do the following:

1. Wait for this message to appear on the VDT screen (within about 60 seconds):

PLEASE TURN THE LINE PRINTER ON AND 'CR'

2. Press the printer ON-LINE switch; the light comes on.
3. Press the 'CR' key at the VDT keyboard.
4. Press and hold down the printer FORMS switch until the page currently being printed is completed.
5. Reload a new supply of forms and adjust to top of form.
6. Press the ON-LINE switch so that the indicator light comes on.
7. Press 'CR' and your report will continue to be printed.

Adjusting for Forms Thickness and other Special Situations

The System 200/410 printer can print up to five copies plus the original. When you use multiple thickness forms, move the platen farther away from the print head. You may also need to make this adjustment when using papers of varying thickness or to compensate for ribbon wear.

Adjustment knob

This knob is to the left of the platen. Turn the knob clockwise to move the platen closer to the print head, counterclockwise to move platen farther from print head. Test the printer for proper performance, then adjust the knob again as needed (Figure 52).

Adjustment settings

The number scale for print head settings ranges from 1 to 6, and proper settings may vary for each printer. Use a chart similar to the one shown here to record settings for the different forms you use. Then you won't need to test the adjustment with each use.

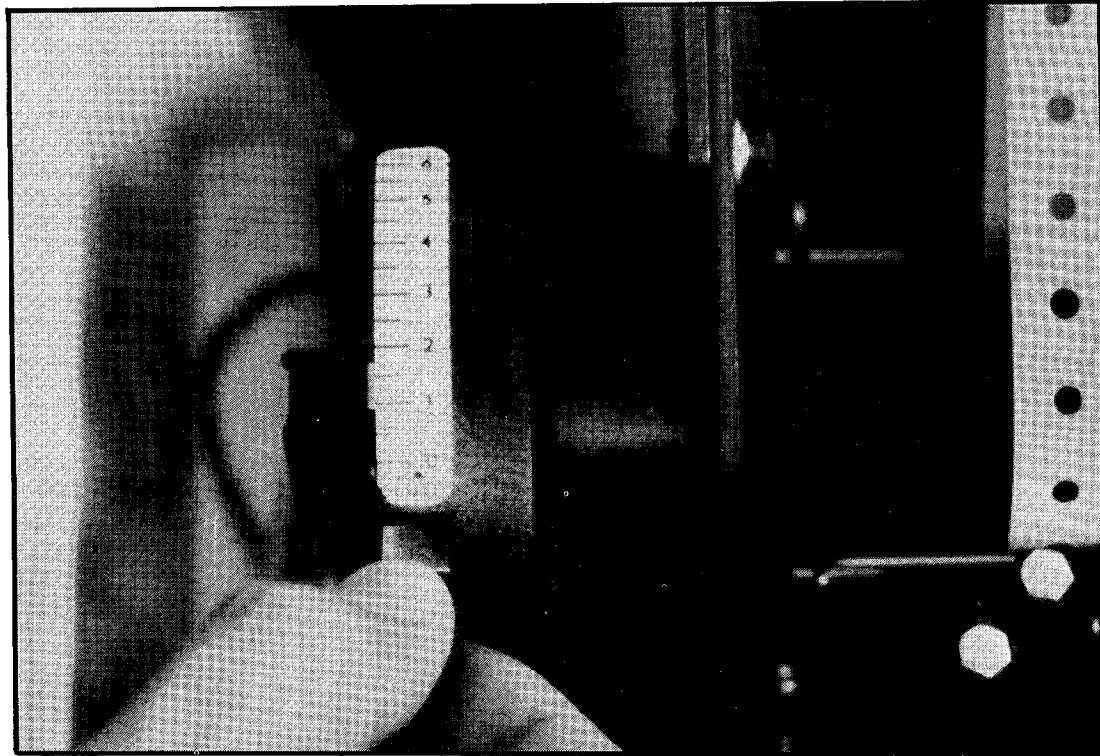

Figure 52. Adjusting for forms of different thickness

Form Name or Number	Parts	Setting

Changing at end of page

Because inserting a new ribbon or adjusting the forms thickness may change the darkness of the print or letter density, wait until the last line on a page is printed to make a change. Then press the ON-LINE switch for a moment. The light will go off, and the printer will be off-line or stopped.

Clearing a paper jam

If the paper jams during operation, stop the printer immediately by pressing the ON-LINE switch to off. If it becomes necessary to move the print carriage in order to clear the jam, the power must be turned off. **Do not move the carriage manually with the power on.**

Moving to end of page

If desired, you can "step" the printer to the end of the current page by depressing the ON-LINE switch twice quickly. This momentarily selects, then deselects the printer, causing it to print one line at a time. After changing the ribbon or adjusting the forms thickness, press ON-LINE again to allow the printer to continue from where it was stopped.

Paper stacking

Both long and short reports may be stacked safely on the lower metal stacker on the back of the printer stand. To insure an even flow of paper, there is a paper guide attached to the top of the printer. This allows the printed forms to flow over the guide down the back of the printer onto the paper stacker (Figure 53).

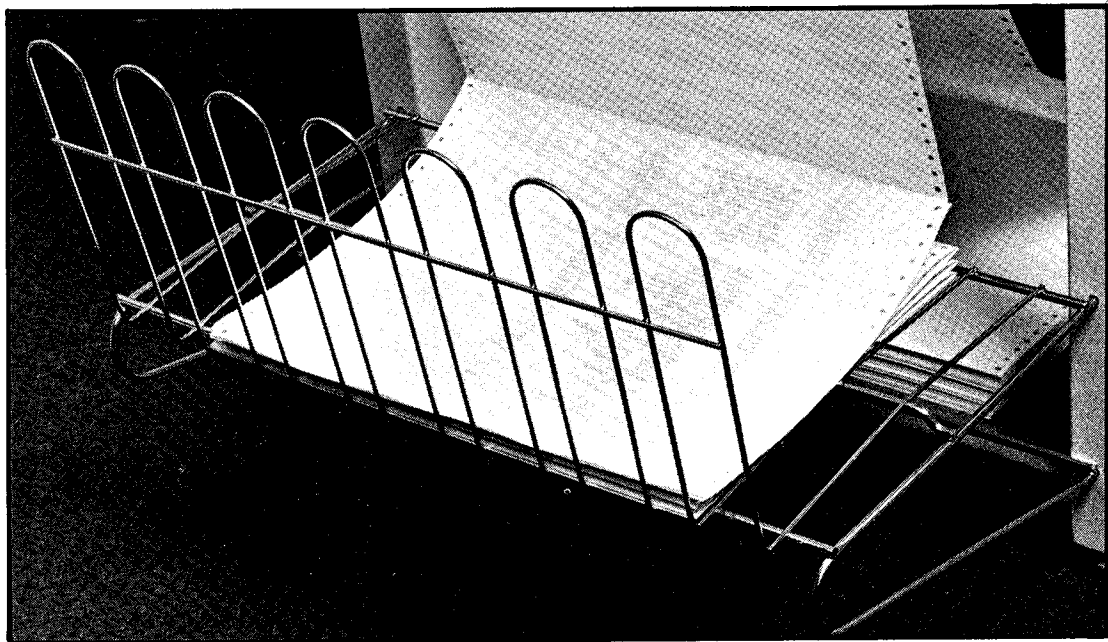

Figure 53. Printed report stacker

REPLACING PRINTER RIBBON

Replacement considerations

The printer ribbon is just like a typewriter ribbon: when the printed line becomes too faint, simply change the ribbon. You will normally need to replace the printer ribbon after approximately 50,000 lines of use. In theory, this figure will vary depending on the printing quality required and

the number and distribution of characters printed on the average line. In practice, the ribbon may require daily replacement or may provide adequate quality after much use.

Ribbon supply

The Basic Four System 200/410 requires BFC Part Number 3908 for 120/160 lpm printers. Please keep your hands and the printer clean by wearing plastic gloves when changing the ribbon.

Power switch off

Turn off the printer by pressing the ON-LINE and POWER switches off. Open the printer cover.

Avoiding ink smudges

Keep your hands and the printer clean by wearing the plastic gloves supplied with the new ribbon.

Removing old ribbon

Remove the old ribbon and discard. As the ribbon is removed, two spring-loaded tension arms will move to resting positions (Figure 54).

Installing new ribbon

Place the almost-empty new spool on the righthand axle (hub B) as you face the printer. Place the full spool on the lefthand axle (hub A).

Lifting ribbon past lefthand tension arm

Lift the ribbon and swing tension arm no. 1 clockwise under the ribbon. Release ribbon, then tension arm (Fig. 54). Ribbon then goes to the left of roller 2 and through slot 3 (Fig. 55).

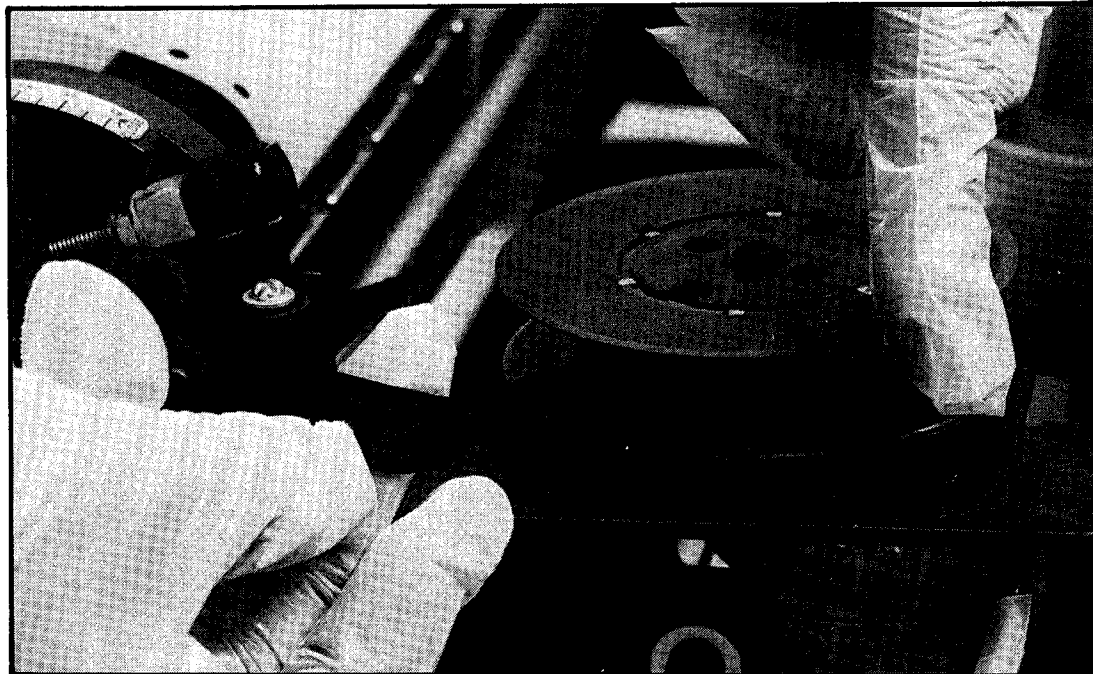

Figure 54. *Lifting new ribbon over lefthand tension arm*

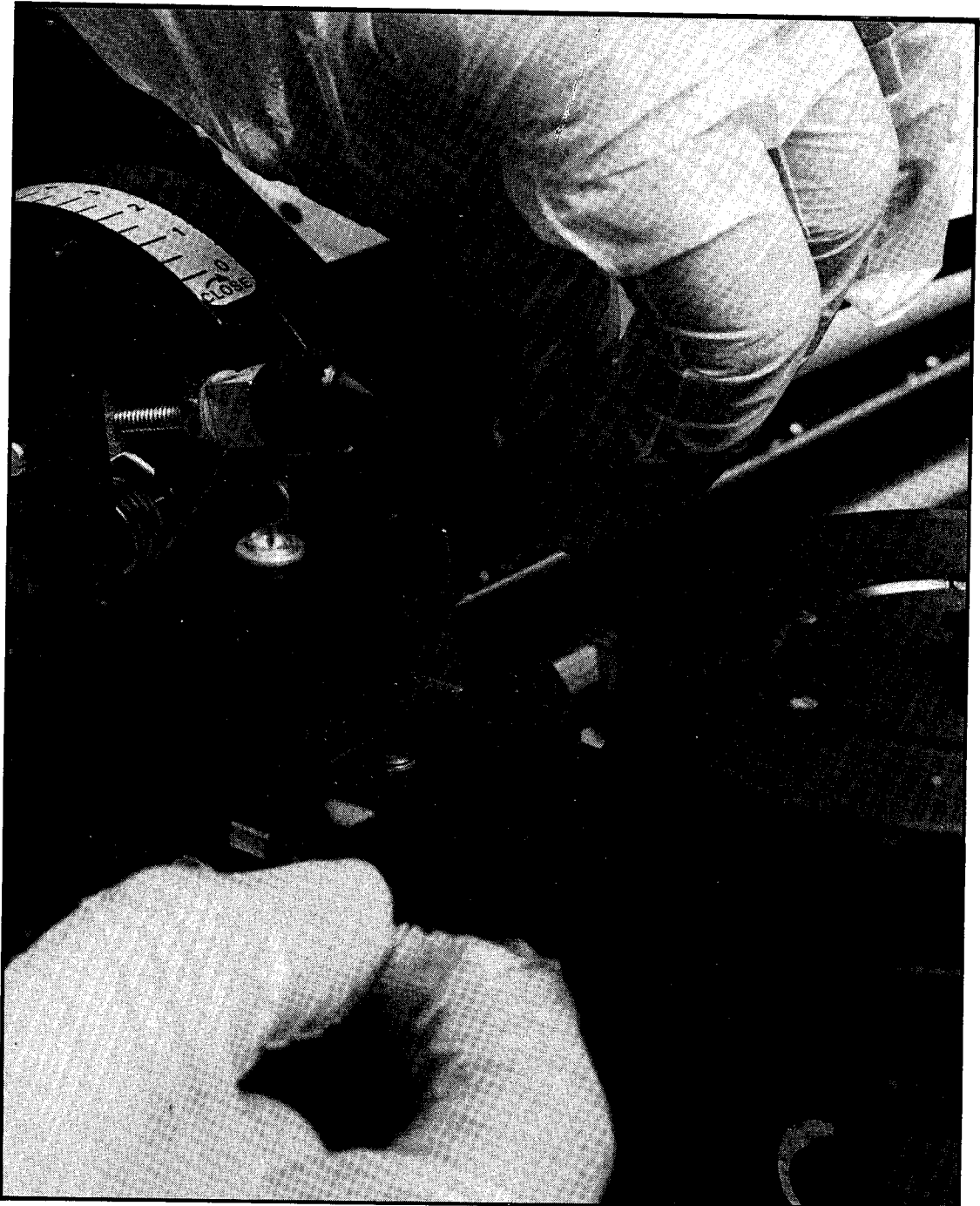

Figure 55. Threading ribbon around roller 2 and slot 3

Threading ribbon, continued

Ribbon goes around rollers 4 and 5, around the end of the printer head (Fig. 56), around rollers 6 and 7, through slot 8, and to the right of roller 9.

Lifting ribbon past righthand tension arm

Lift ribbon and swing arm 10 counterclockwise under the ribbon (Fig. 57). Release ribbon, then tension arm. Make sure both tension arms hold ribbon taut. Close printer cover.

Power switch on

Press the POWER switch on, then wait 20 seconds before going to the next step.



Figure 56. Threading ribbon around printer head

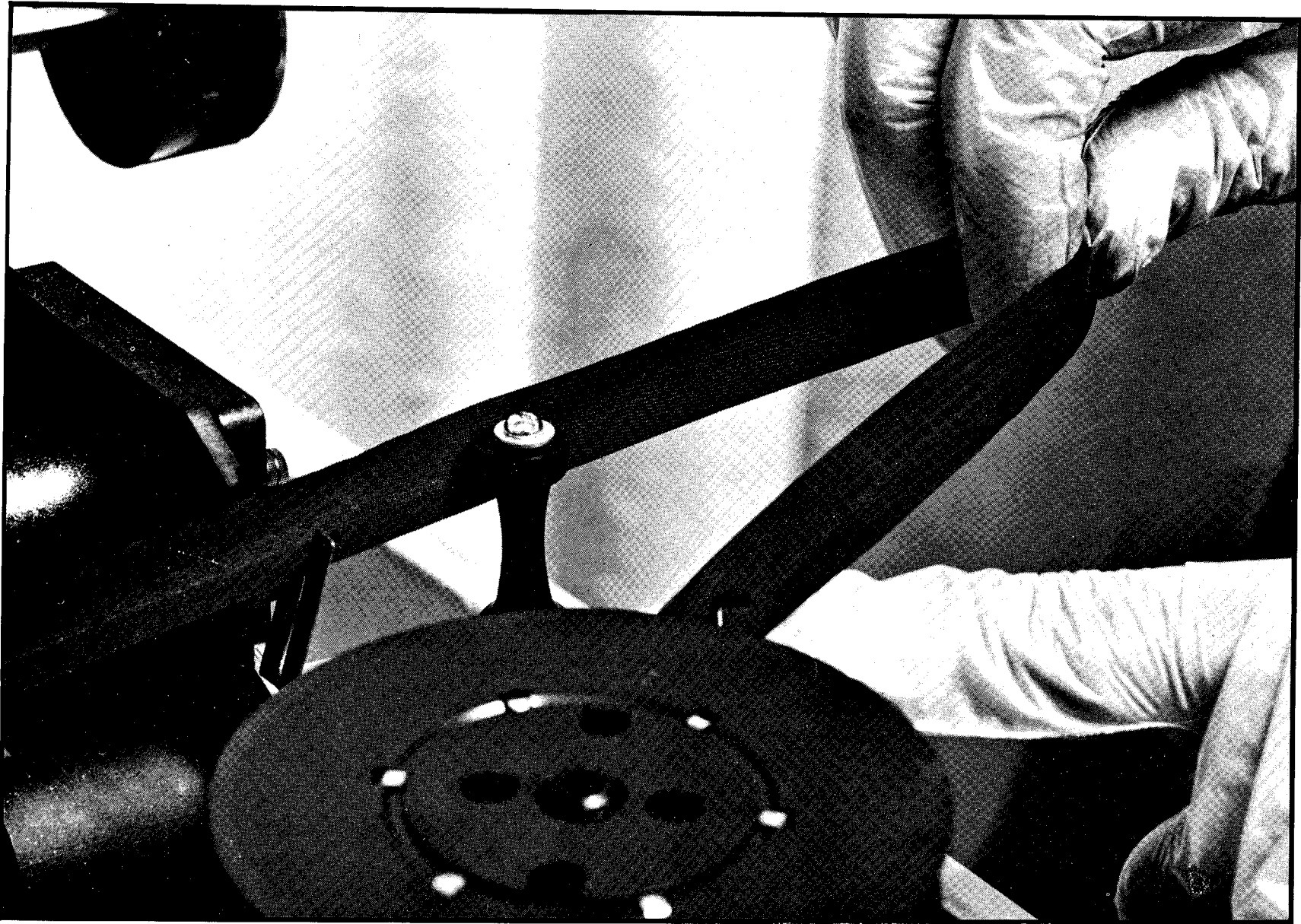

Figure 57. Lifting new ribbon over righthand tension arm

Test pattern

Press the TEST switch so that light comes on. The printer will automatically print a test pattern (Fig. 58). After you are satisfied that the new ribbon has been installed correctly, press the TEST switch again to stop the printer. The TEST light will go out.

Placing the printer on-line

Press the ON-LINE switch on. The printer is ready for use again.

**SYSTEM 410 HARDWARE
OPTIONS**

The System 410 can be enhanced with hardware options that include a 160 cps printer, 150/300 lpm printer, and reel-to-reel magnetic tape drive.

160 CPS PRINTER

Operation of the 160 cps printer is the same as for the 120 cps printer that is standard with the System 410.

150/300 LPM PRINTER

Operation of the 150/300 lpm printer is described here because such operation differs from that of the 120/160 cps printer.

**MAGNETIC TAPE DRIVE,
REEL-TO-REEL**

Operation of the reel-to-reel magnetic tape drive is described here because such operation differs from that of the magnetic tape cartridge drive.

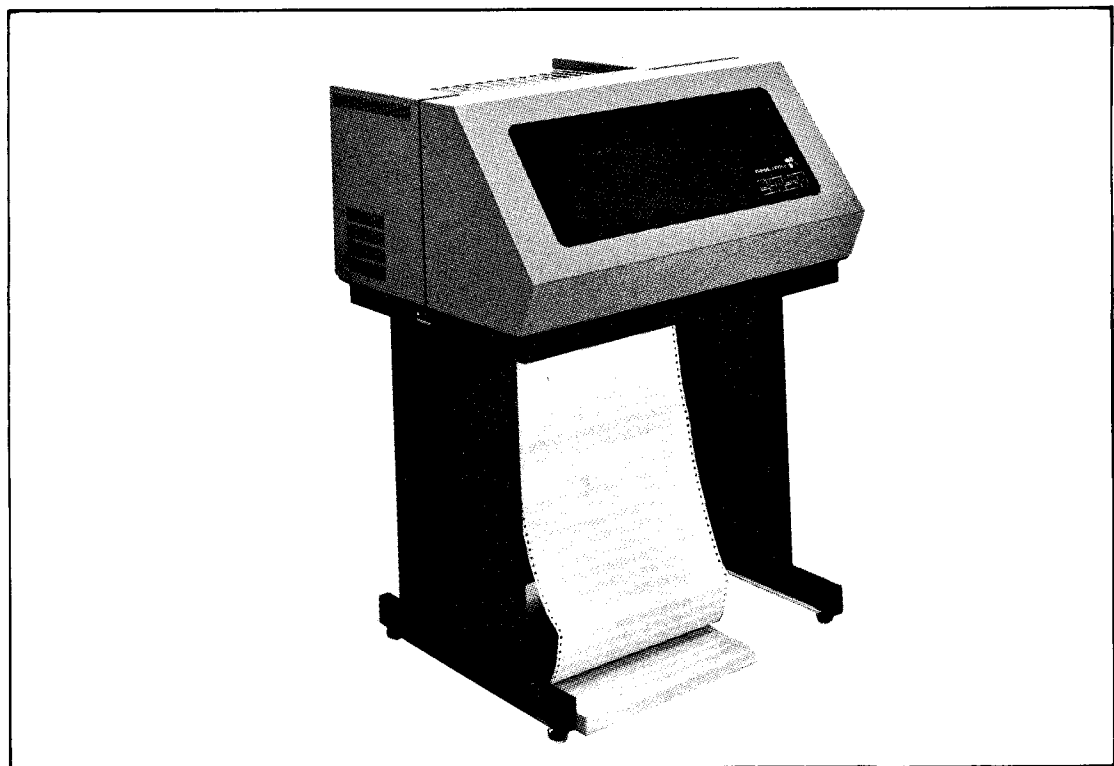
150/300 LPM PRINTER

These line printers produce large volumes of forms and reports at a rate of 150 or 300 lines-per-minute, in addition to having the capability of plotting graphs. They are free-standing and have an enclosure to reduce printer noise.

The printers use forms up to 16 inches wide. Features include heat sensitive switches including a switch for selecting either six or eight lines-per-inch. The printers are available with a standard 96-character

(upper and lower case) type font, produced by a 9 x 7 dot matrix. A paper stacker is included for ease of gathering processed documentation. A forms length selector switch is optional.

SPECIFICATIONS

Printing Rate:	150 and 300 lines-per-minute
Character Set:	96-character (upper and lower) Gothic style equivalent to 10 point type size.
Printer Line Length:	132 characters
Character Spacing:	6 or 8 lines-per-inch, switch selectable
Slewing:	8 inches-per-second
Data Buffer:	Full line, 132 characters
Paper:	4-1/2 to 16 inch wide, sprocket fed, single or multiple part forms
Copies:	Original plus five
Paper Feed:	Pin feed (half-inch, center-to-center holes) continuous fan fold forms

PRINTER ADJUSTMENT

The adjustment controls (Figure 1) permit the operator to make certain preliminary adjustments that may be required before printer start-up.

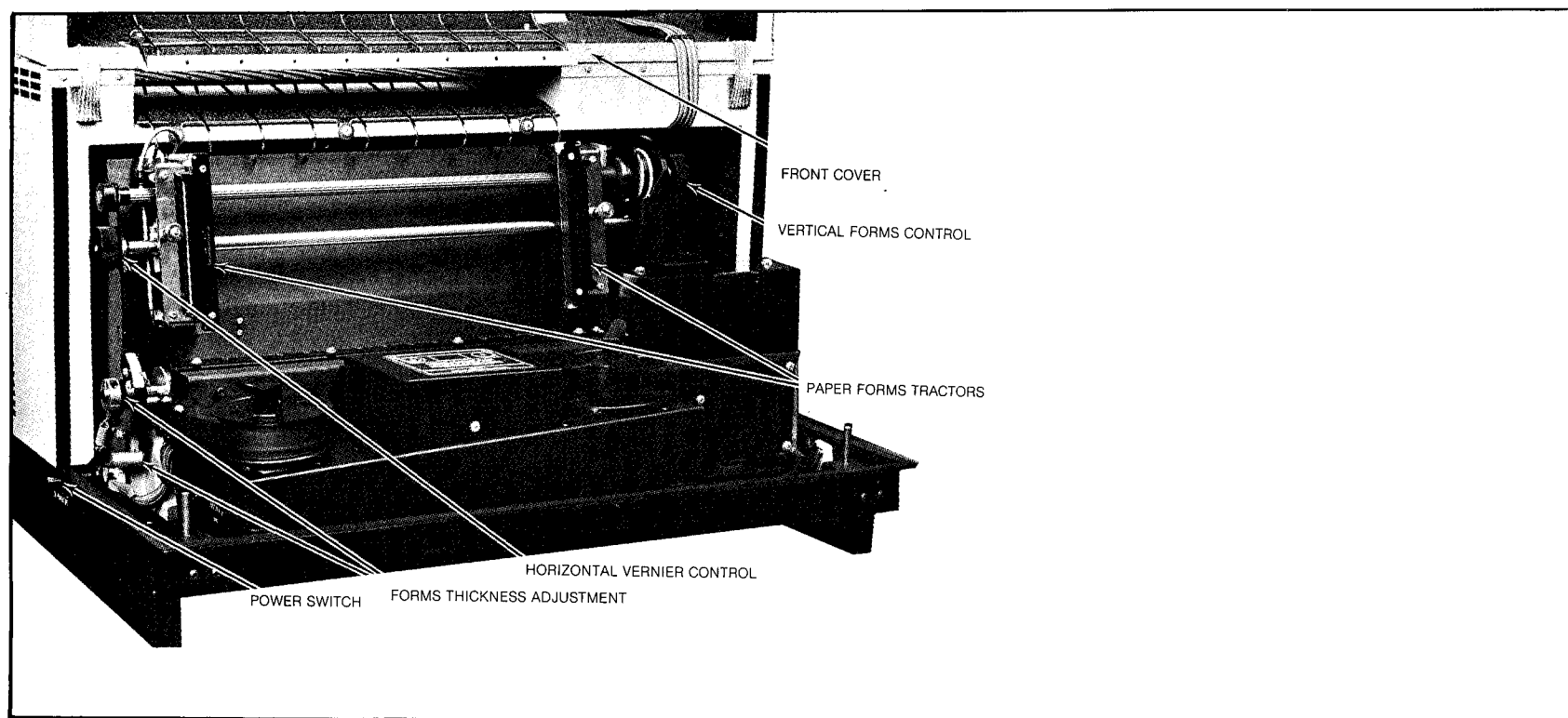

Figure 1. Adjustment Controls

ADJUSTMENT CONTROLS

Power Switch - The ON/OFF toggle switch, located on the lower left side (toward rear) applies AC power to the printer.

Horizontal Vernier Control - Permits lateral adjustment of the tractors over a range of approximately two character widths providing accurate horizontal registration of printing on preprinted forms.

Forms Thickness Adjustment - Positions the platen to accommodate a range of form thicknesses (one to six). When raised to the uppermost position, this adjustment opens the platen, allowing the insertion or removal of printer forms.

Paper Forms Tractors - The tractors may be moved to accommodate forms ranging from 4-1/2 to 16 inches in width.

Vertical Forms Control - Permits accurate vertical form positioning.

OPERATOR CONTROLS

Switches and Indicators

The control panel (Figure 2) contains the functional switches and light indicators that are used in the printing procedure.

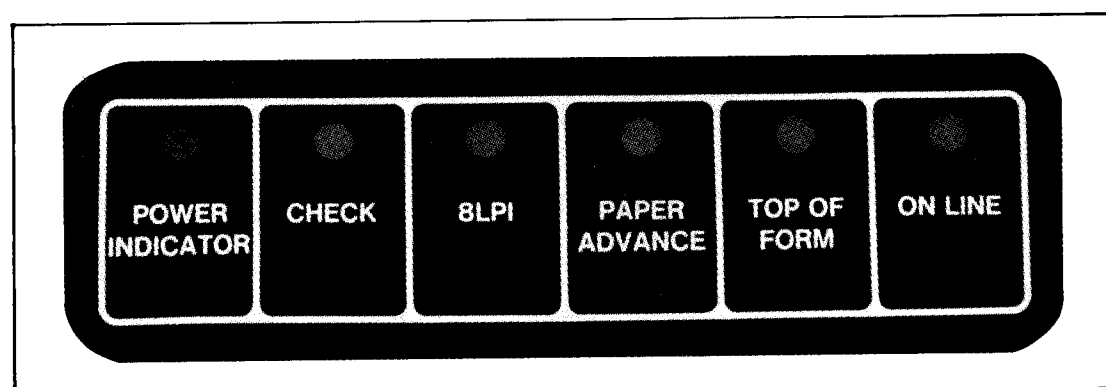

Figure 2. Control Panel

Power Indicator - This indicator will light when AC power switch is in the ON position.

Check - This combination switch/light indicator will light when printer is not loaded, when the printer has run out of paper, or when paper is torn below the print station or is jammed. It will also light if voltage levels within the printer reach abnormal levels. This indicator will turn off automatically when a condition is cleared. However, if the paper position detector generated the (paper jam or out of paper) condition, the CHECK switch must be activated in order to reset the indicator.

NOTE

The CHECK switch does not function while plotting. Do not leave printer unattended while plotting.

8 LPI - This combination switch/light indicator selects line spacing of either six lines or eight lines per inch. It will light only when eight line per inch spacing is selected.

Paper Advance - This switch will cause paper to advance at a rate of eight inches per second.

Top of Form - This combination switch/light indicator causes a paperfeed cycle, which advances paper to the top of the next form. It is operational only when the printer is off-line (ON-LINE indicator is not on).

On-Line - This combination switch/light indicator places the printer in an on-line and ready condition. The printer cannot go on-line if the CHECK indicator is on.

To properly load paper into the printer, the following steps must be performed:

PAPER LOADING

- Open front cover.
- Raise Form Thickness Adjustment to LOAD position.
- Open left and right tractor gates (Figure 3), and remove any remaining paper.

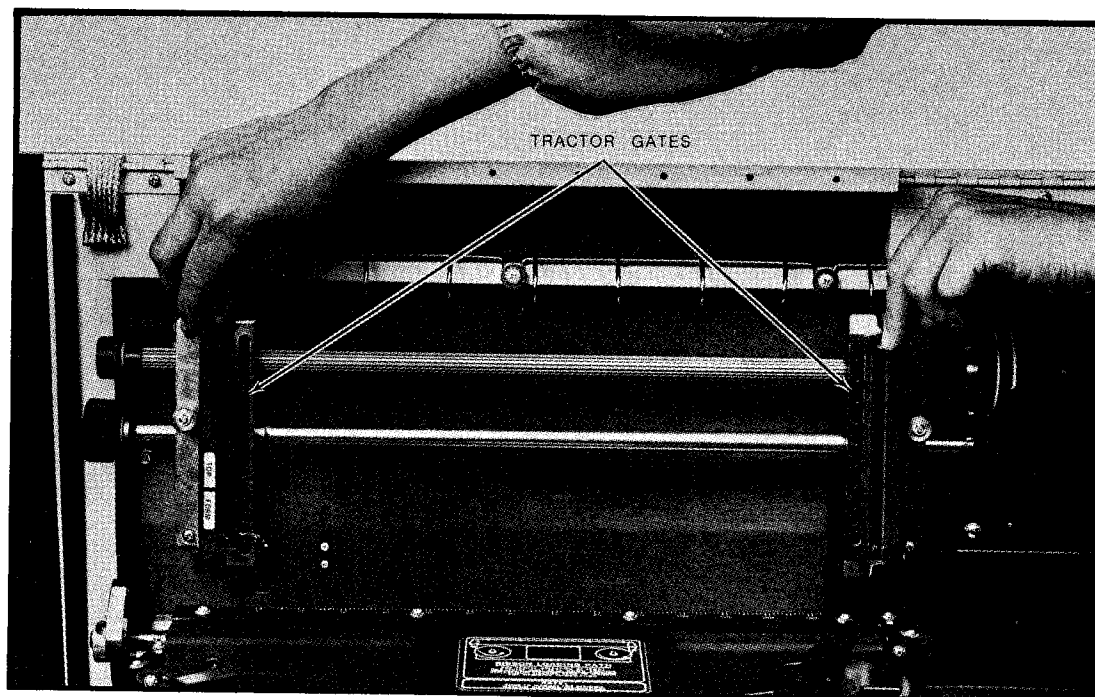

Figure 3. Tractor Gates

- Insert top edge of paper through slot in bottom of printer and move it upward until top paper edge can be grasped above print station (Figure 4).

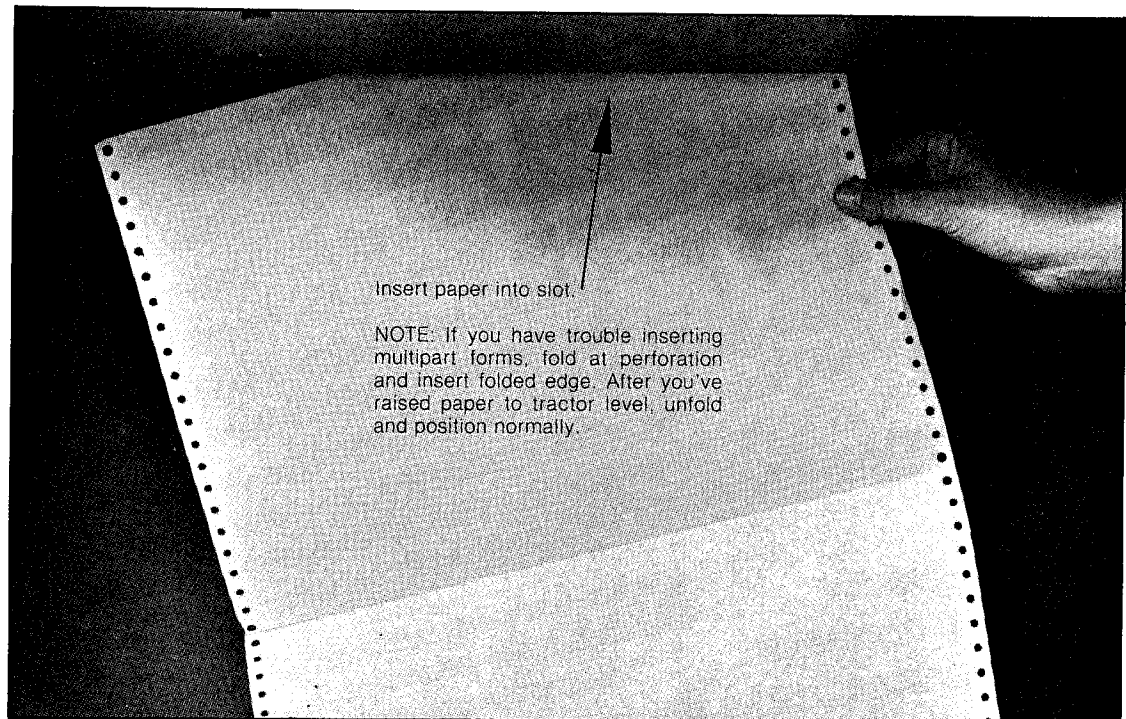

Figure 4. Inserting Paper

- Keeping paper parallel with tractors, raise and position it on tractor feed pins (Figure 5). If paper is too wide or too narrow to fit on both tractors, loosen knurled nut on right hand tractor and move tractor until feed pins and sprocket holes line up. Position paper on feed pins and close tractor gates.
- The tractors should be adjusted to create slight tension across paper. Too little tension may result in wavy print lines; excessive tension may distort or tear sprocket holes.
- The paper should be positioned so that the first character position falls in the desired first column position on the paper. This may be accomplished by adjusting the Horizontal Vernier Control or loosening the knurled nut on each tractor and moving the tractors to the desired position.

NOTE

Be sure that paper is positioned so that the left side covers all of the paper-out detector surface. The printer will not go ready if the paper-out detector is not covered.

- With Forms Thickness Adjustment still in LOAD position, turn Vertical Forms Control knob so that first print line position is aligned with top-of-form indicator on tractors (Figure 6).

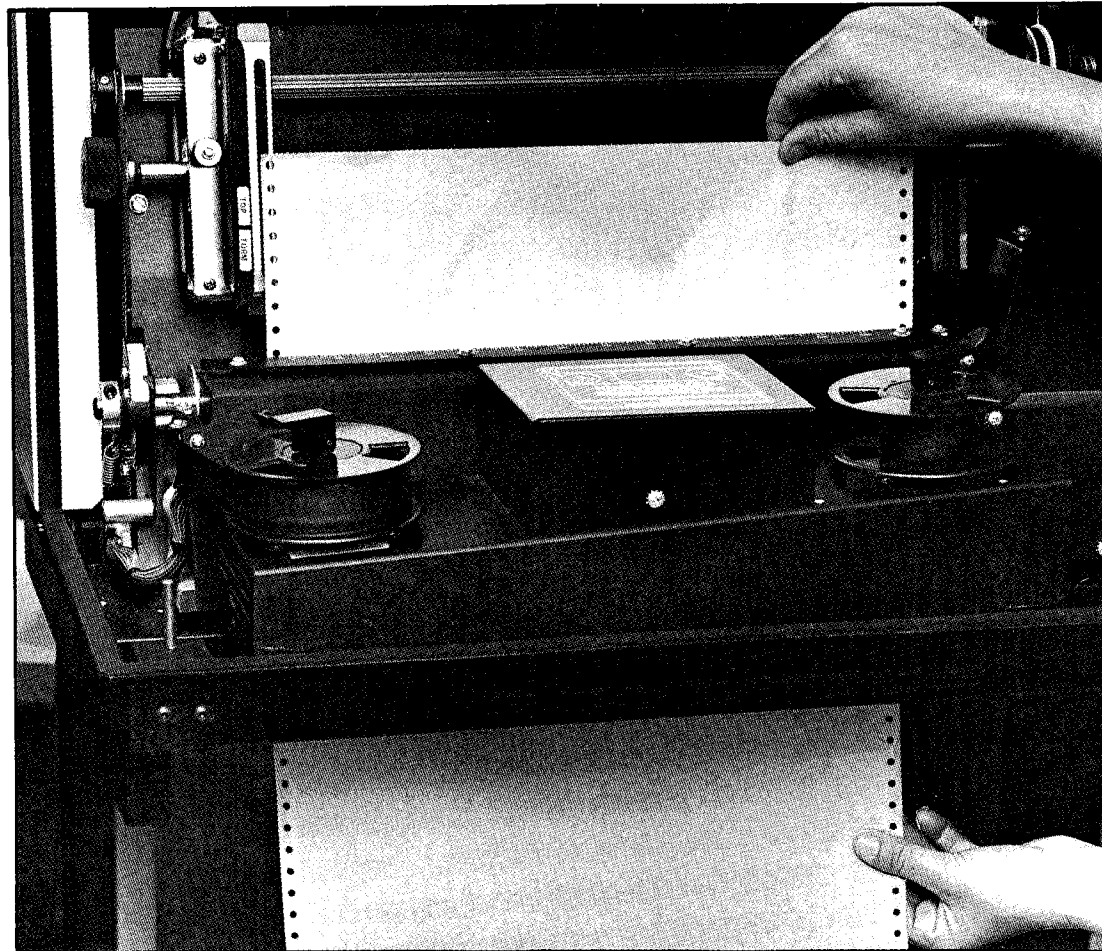

Figure 5. Positioning Forms

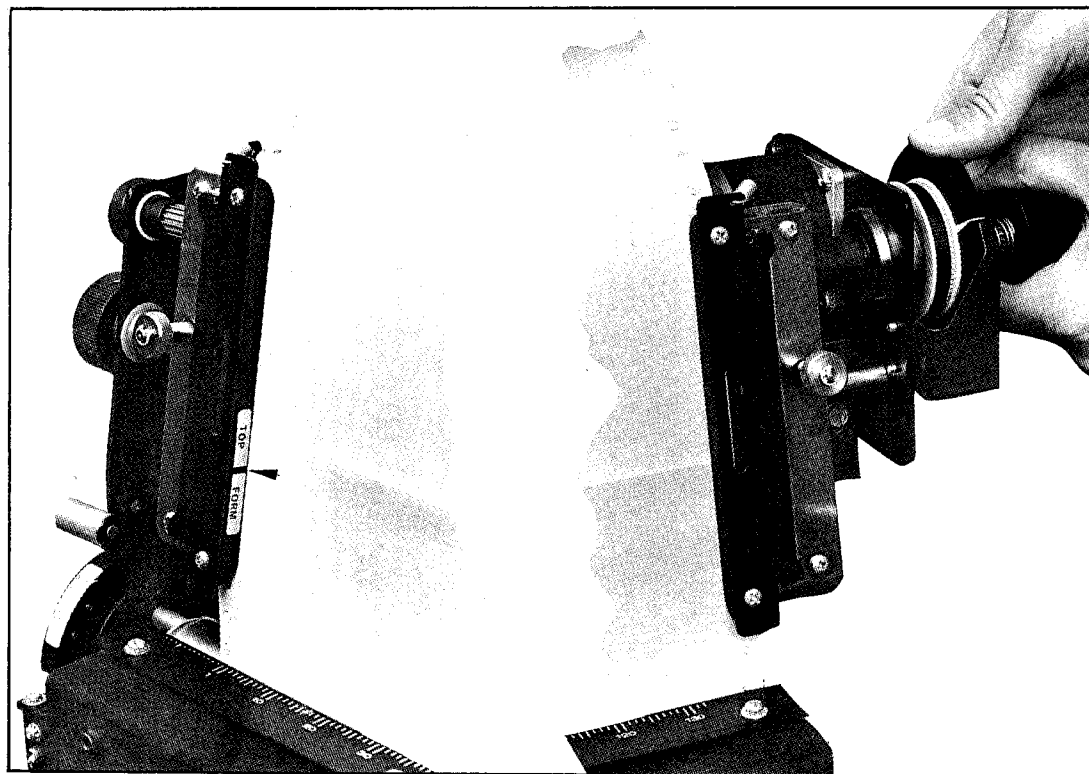

Figure 6. Aligning First Print Line Position

- Align paper indicator mark on Vertical Forms Control wheel with pointer, then rotate knob exactly one revolution to lower paper to proper position. Indicator mark should once again be aligned with pointer (Figure 7).

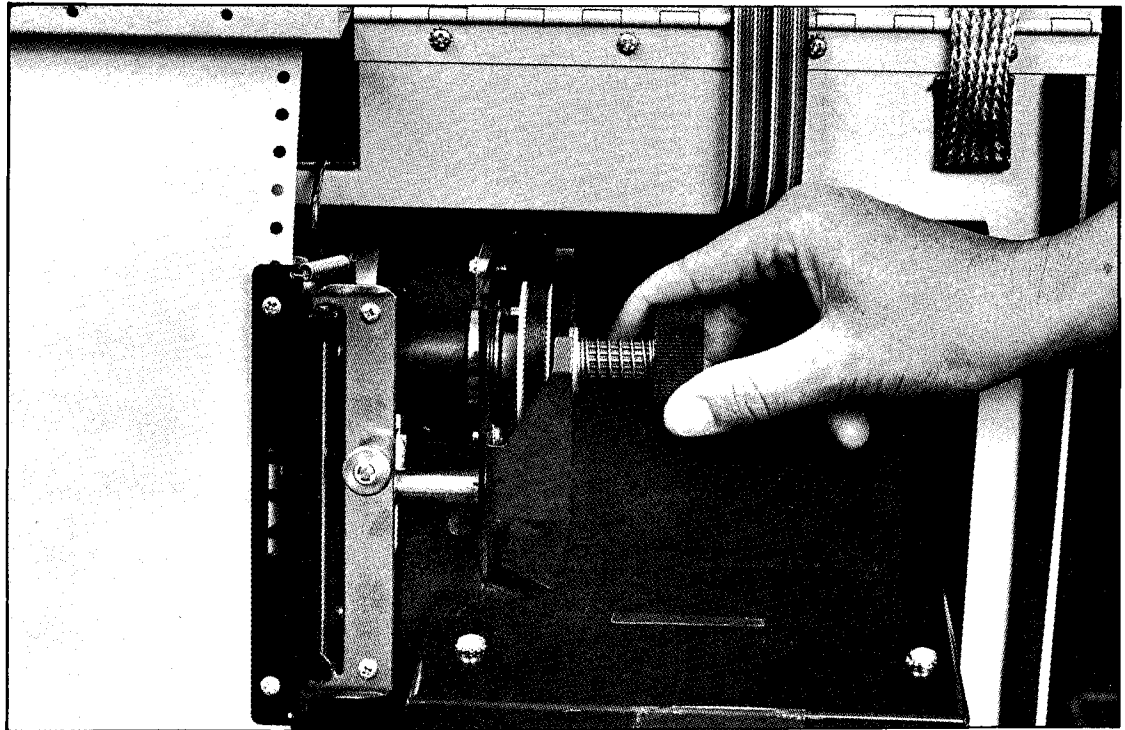

Figure 7. Aligning Top of Form

- Grasp paper on both sides below entrance slot, and gently pull downwards so that paper is taut within printer (Figure 8).

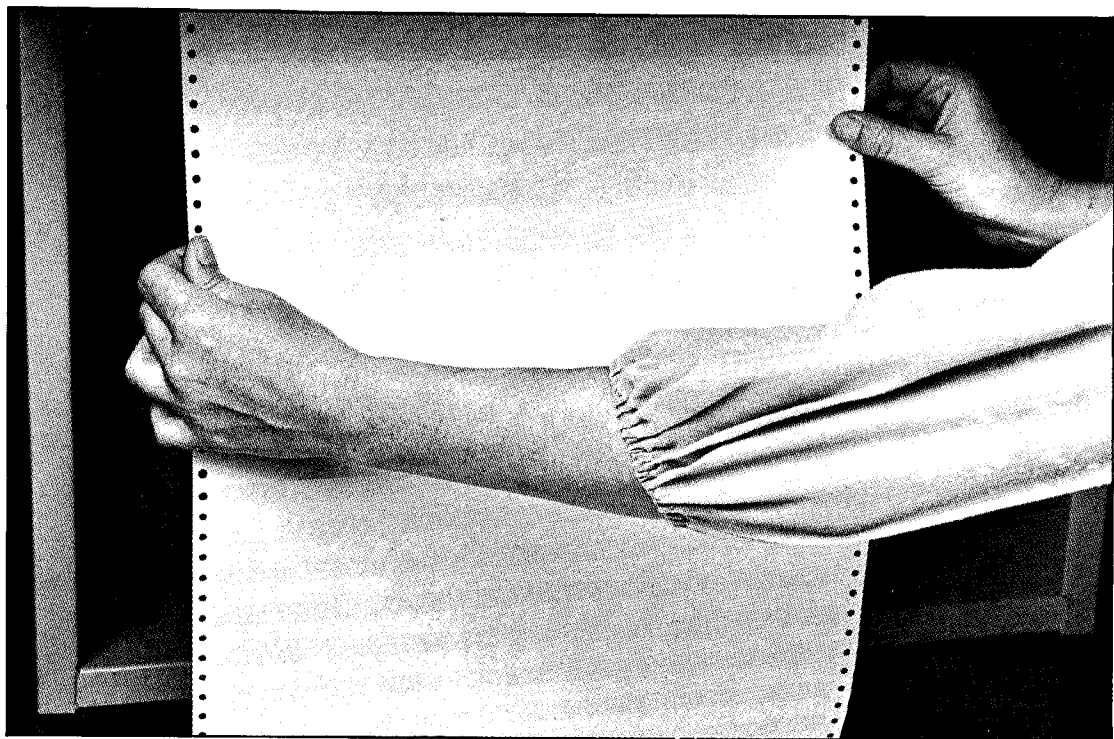

Figure 8. Tensioning Form

- Move Form Thickness Adjustment downwards to the desired position: single, 3-part, 6-part, or an appropriate intermediate position.

CAUTION

If the Form Thickness Adjustment is inadvertently left open or positioned incorrectly for the thickness of the form, printing may not occur and the ribbon may be destroyed.

- Close front cover and activate TOP OF FORM switch. If CHECK indicator comes on, paper is positioned incorrectly.

VERTICAL FORMS UNIT (VFU)

The line printers utilize an electronic VFU which operates under program control. If Top Of Form or slewing operations do not function properly, contact your systems programmer for assistance.

RIBBON REPLACEMENT

Ribbon life drops off sharply if ribbon guides and the overall ribbon guide path are not kept clean. This includes rollers and guides. Cleaning should be done prior to putting on a new ribbon, or sooner if it is determined that dirt or ink buildup on these parts has contributed to printing degradation. It is recommended that a soft lint-free cloth and isopropyl alcohol be used for this purpose.

The inked ribbon is one inch wide and should be replaced after approximately 120,000 lines of print:

- Turn AC power OFF, open front cover, set Form Thickness Adjustment to LOAD position.
- Rotate either reel to obtain slack in ribbon.
- Raise lock lever on each hub, lift off ribbon spools and clear ribbon from left and right guides (Figure 9).

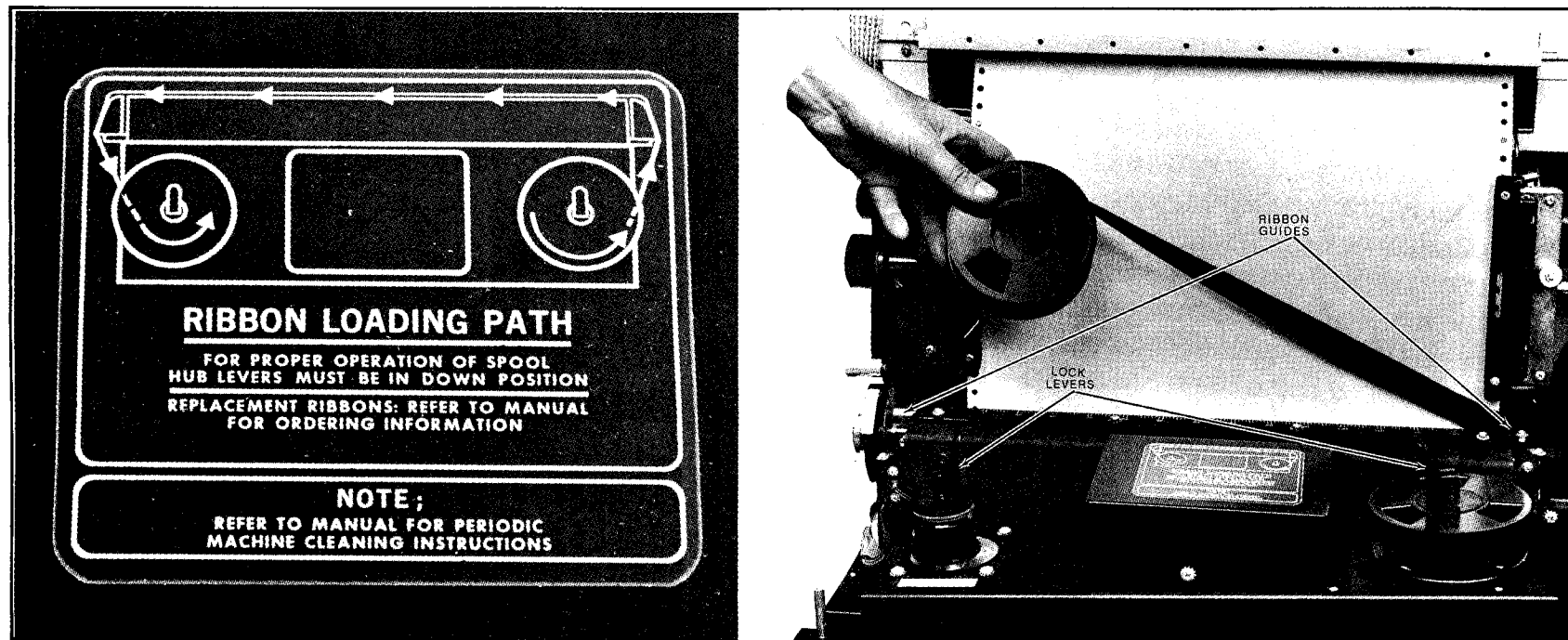

Figure 9. Replacing Ribbon

- Place supply reel on left-hand hub and lower lock lever, locking reel on hub. Holding take-up reel, run ribbon over ribbon guides following path shown in diagram on ribbon deck. Place take-up reel on right-hand hub and lower lock lever.
- Rotate either reel to take up slack and verify that ribbon runs smoothly and is not twisted.
- Place AC power switch in ON position.
- Set Form Thickness Adjustment to desired setting.
- Close front cover.

CAUTION

Be sure that end-of-reel sensor wires are NOT on the hammer bank side of the guides with ribbon installed. This would cause ribbon to wear out very quickly.

ROUTINE MAINTENANCE

The following maintenance should be performed by the operator to ensure proper operation of the printer.

The printer should be kept clean, both inside and outside, to ensure proper operation. The platen should be opened, paper removed, and the area around the platen dusted with a soft brush and/or vacuumed weekly, as often as required.

The printer case can be cleaned as required using household liquid cleaner. Do not use steel wool, abrasive cleaners, or any type of solvent cleaners. These cleaners may damage the painted surface.

PAPER SPECIFICATIONS

The following are recommendations regarding the correct types of forms to be used with the Basic Four printers. The carbon weights as well as the various paper weights are given as a guideline for selecting the proper paper.

**Stock Forms and
Standard Construction
Custom Forms**

- Single Copy — 15, 18-, or 20-lb. bond
- 2 and 3 Copies — 15-lb., 7-lb. carbon
- 4 and 5 Copies — 12-lb. bond, on first sheet and intermediate copies, 15-lb. bond on last copy, 7-lb. carbon
- 6 copies — 12-lb. bond on first sheet, 10-lb. bond on intermediate copies, 15-lb. bond on last copy, 7-lb. carbon

Carbonless Papers

- 6 copies — 14 or 15-lb. carbonless paper in white or colors, 15 or 16-lb. white or colors in last position
- 10 copies — 10-lb. white carbonizing bond (carbon-backed), 15-lb. bond recommended for last copy

The printers will also accept other types of continuous forms. For any special purpose forms see your forms salesman. All forms other than stock forms should be tested prior to purchase.

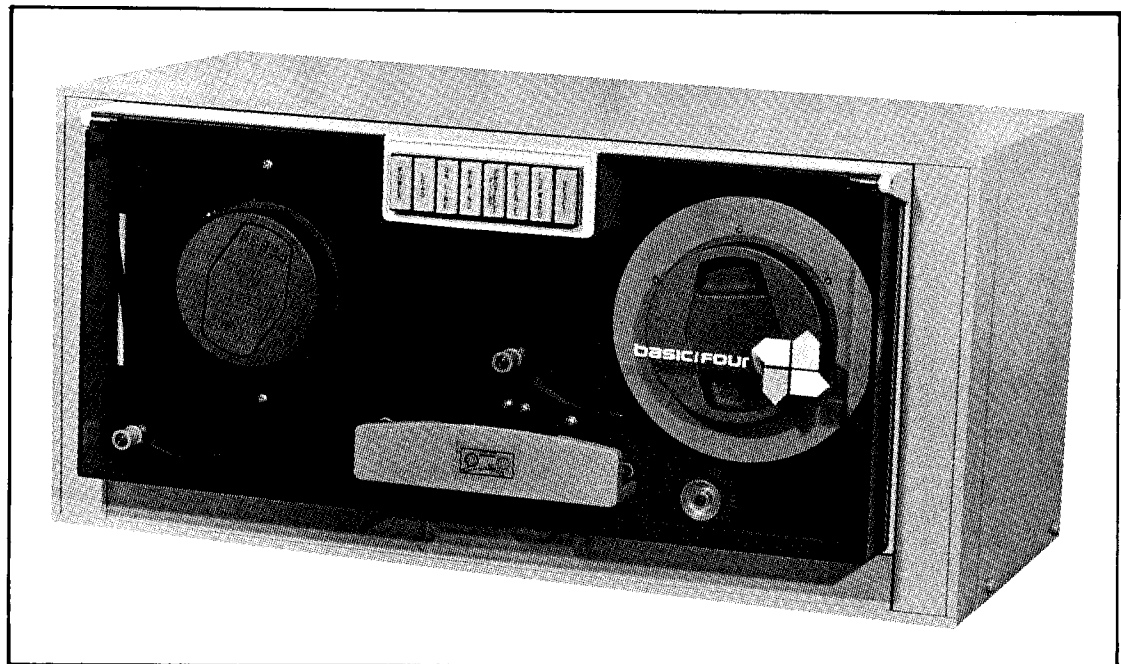
**MAGNETIC TAPE DRIVE
(Reel-To-Reel)**

The magnetic tape drive provides a means of storing large volumes of data. This unit can be used in applications where the faster data access time of the disc drive is not needed.

SPECIFICATIONS

Tape Velocity:	12.5 inches per second.
Data Transfer Rate:	2,300 to 10,000 characters per second.
Rewind Velocity:	50 inches per second (nominal).
Compatibility:	9-track
Tape:	Computer grade, 0.5 inch wide, 1.5 mil. thick.
Reel Size:	7-inch maximum diameter, IBM hub compatible.
Data Density and Recording Mode:	800 bpi with NRZI recording mode.

OPERATOR CONTROLS

During normal operation of the tape unit with the computer system, tape motion and the reading or writing of data are controlled by the CPU. When the tape system is not under computer control (i.e., when it is off-line), tape motion can be controlled by the operator through pushbuttons on the control panel (Figure 1). Indicator lights are also provided to show the conditions under which the equipment is operating.

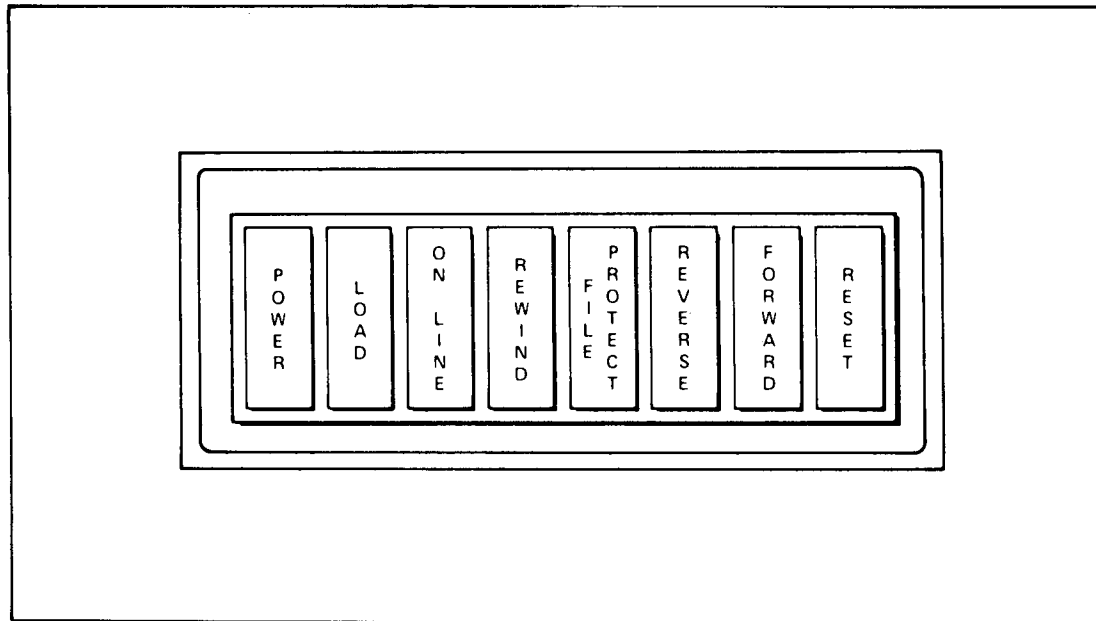

Figure 1. Control Panel

Switches and Indicators

Power - This is a combination alternate action switch/indicator which controls power to the unit. The indicator lights when power is on.

Load - After threading the tape, press this combination pushbutton switch/indicator to complete the tape loading operation. Tape is automatically advanced to the load point, or beginning-of-tape marker, and then the tape system goes on-line. LOAD and ON-LINE indicators will light when the action is completed. The LOAD light will go out when the tape is either advanced from the load point or rewound; however, it will light any time that the tape is positioned at the load point.

On-Line - This is a combination pushbutton switch/indicator. It lights when the system is under control of the computer. If the system is off-line and if control is to be turned over to the computer, press the ON-LINE pushbutton.

Rewind - Pressing this pushbutton switch will result in rewind of the tape with high-speed reverse operation. The operator can stop this reverse motion by pressing the RESET pushbutton. If RESET is not pressed, the tape will go beyond the beginning-of-tape marker, stop, and then automatically return to the load point. If the REWIND pushbutton is again pressed, the tape will be drawn out of the tape path and the unload sequence will be completed. If the tape system is under computer control, the REWIND pushbutton will not function. This safety feature prevents accidental tape damage.

File Protect - This indicator lights when a write enable ring is not installed on the supply reel. When a supply reel is loaded with the write enable ring in place in the slot at the back of the reel, the FILE PROTECT light will be off. This indicates that data can be written on the tape. Without the ring, protective circuits in the tape system prevent data from being written, which would in turn erase data previously written on the tape.

Reverse - If the ON-LINE indicator is on, pressing the REVERSE pushbutton will not affect the operation of the unit. If the tape unit is off-line, pressing this switch will cause the indicator to light and move the tape in reverse at the normal tape speed. To stop the tape unit when it is running in this mode, press the RESET pushbutton.

Forward - This combination pushbutton switch/indicator will function only when the unit is off-line. If the ON-LINE indicator is on, pressing the FORWARD pushbutton will have no effect. If the ON-LINE indicator is off and the FORWARD pushbutton is pressed, the indicator will light and the tape unit will move tape in the forward direction at the normal tape speed. To stop the tape unit when it is running in this mode, press the RESET pushbutton.

Reset - All tape motion, regardless of the command that established it, will stop when the RESET pushbutton is pressed. Pressing RESET also removes the tape unit from on-line operation with the computer and turns off the ON-LINE indicator.

TAPE MOVEMENT CONTROL

When the system is operating, the speed and direction of the tape are determined by the capstan. The capstan pulls the tape past the head assembly so that it may be either written or read. For the tape system to operate efficiently, the tape must be started and brought up to speed as quickly as possible. The weight of the tape on the reels prevents the reels from starting as rapidly as the capstan, so a small

length of tape is held by buffer arms near the supply and takeup reels. When the capstan starts quickly, the buffer arms are either pulled in or released by the tape motion. Changes in the position of these arms result in the supply and takeup reels either feeding tape to the capstan or taking up the slack created by the capstan motion.

END OF TAPE DETECTION

Reflective markers at either end of the tape prevent it from being pulled completely from either the supply or takeup reels, except when the operator wants to change the reel. A sensing post near the read/write head assembly illuminates the tape and issues a stop signal when the marker is detected. Markers for the beginning and end of the tape are on opposite sides, providing to the computer or data system an indication of which end of the tape has been reached.

TAPE LOADING

Operation of the tape system requires only a few simple procedures. These include tape loading and unloading, manual rewind, and power failure recovery.

Tape loading is made particularly easy by the toggle action hold-down knob for the supply reel. Positive indication is provided by the knob for installation of the reel and for the locked condition.

Reel Installation

To prepare the knob for installation of the reel, depress the toggle at the end marked PRESS. It will remain in that position. Place the tape reel on the knob with the write enable ring or the slot provided for it, toward the tape unit. This will automatically position the end of the tape on the reel for proper threading. After pressing the reel firmly against the knob, using the fingertips against the reel hub only, press the extended end of the toggle until it is flush with the face of the hold-down knob. The snap action of the knob will be distinctly felt, indicating that the knob is firmly locked.

CAUTION

Care should be taken to avoid pressing the reel flanges against the tape pack when loading the tape or locking the knob. Pressure of the flange against the tape edges causes two types of damage: (1) oxide is dislodged from the film, causing potential read errors; and (2) deformity of the edge of the tape results in misalignment of the tape as it passes the head, with an increased possibility of errors.

Tape Threading

The following procedure is used to thread the tape (Figure 2):

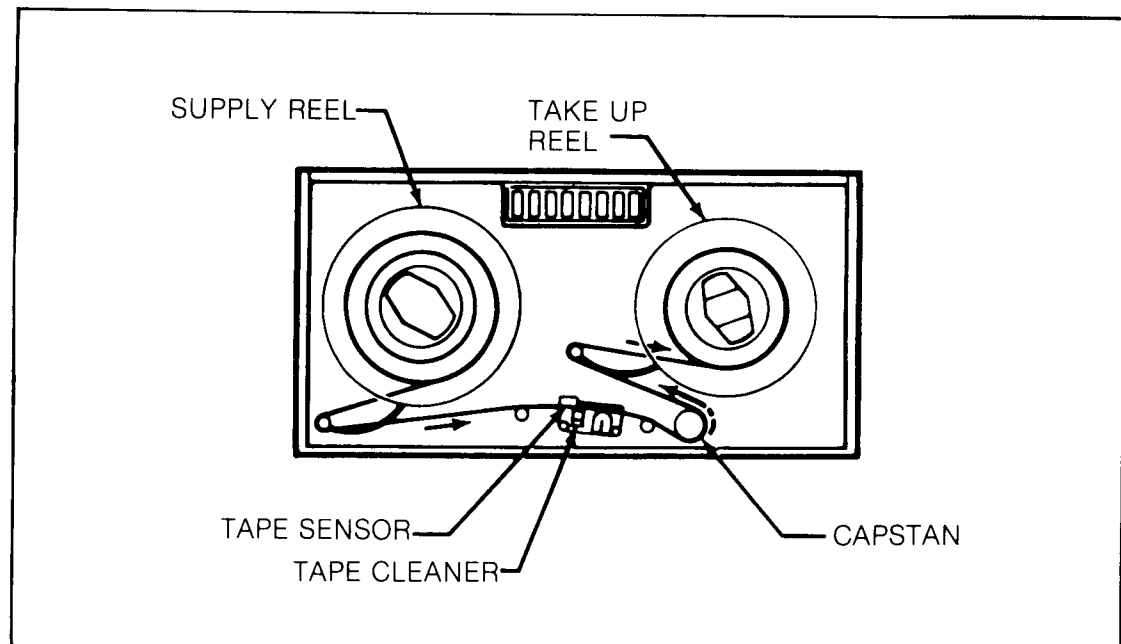

Figure 2. Tape Threading

- Lead the end of the tape over and around the left side of the buffer arm guide.
- Continue across the head assembly from left to right by passing over the fixed guide, tape cleaner, head, and second fixed guide to the capstan.
- At the capstan end of the head assembly, lead the tape below and around the right side of the capstan.
- Pass the tape around the left side and over the top of the other buffer guide.
- Lead the tape below and around the right side of the fixed takeup reel.
- Press the tape end against the top of the hub.
- Holding the tape against the hub, turn the reel until the end of the tape is overlapped and secured by the next tape layer.

- To complete the loading operation, firmly press the LOAD pushbutton. Both buffer arms will move to their normal operating positions and the capstan will pull the tape forward until the beginning-of-tape marker reaches the photosensitive assembly. Control of the tape system will then be turned over to the data system automatically, and the ON-LINE and LOAD indicators will light. No operator action is needed to put the tape system on-line.
- If the on-line mode is not desired, the tape unit may be taken off-line for control from the operator's control panel by pressing the RESET pushbutton.

TAPE CLEANER

To provide the greatest assurance that data on the tape will be read correctly, the tape is cleaned just before it gets to the head assembly. The tape cleaner has small holes into which loose dirt or oxide is deposited as the tape is drawn across the cleaner. For optimum system operation, the dirt must be removed from the cleaner periodically.

REWINDING

At the conclusion of a tape system operation with the computer, or at other times when it is necessary, the tape will be rewound onto the supply reel. Normally, the computer will issue a rewind command without operator participation. Other conditions will sometimes require the operator to rewind the tape by pressing the REWIND pushbutton on the operator control panel. This will result in high-speed reverse operation. When the beginning-of-tape marker reaches the photosensitive unit, the rewind will be ended, and the tape unit will advance until the reflective marker is at the photosensitive head.

TAPE UNLOADING

To unload the tape, press the REWIND pushbutton. The tape will be pulled through the tape path and returned to the supply reel. The tape reel may then be removed from the tape unit by pressing the toggle to the unlock position. Again, care should be taken to avoid damage from pressing the reel flanges against the sides of the tape.

In the event of power failure while the system is on-line, the buffer arms will be relaxed, preventing any possible tape damage. When power has been restored, tape system operations may be resumed by pressing the LOAD pushbutton. When the buffer arms have returned to their operating position, press the RESET pushbutton.

ROUTINE MAINTENANCE

Proper and regular maintenance of the tape unit will assure operation at the high levels of data and mechanical reliability that have been designed into the system. Particularly important are the operator maintenance functions that are intended to keep the system free of dirt and contaminants. At the high densities of data on tapes written or read, extremely small particles of dust or oxide from the tape are capable of causing data errors. Careful attention to the cleaning procedures described below will assure the greatest possibility of trouble-free operation.

Transport and head cleaning should be performed *after every eight hours* of system use in the following manner:

- Remove tape from the tape unit.
- If the installation makes head cleaning more convenient with the head cover off, it may be removed by pulling it gently away from the unit.
- Moisten a soft, lint-free cloth or cotton swab with head cleaning solution. *Do not get the cleaner on your skin.* Many solvents are irritating to the skin, or they may have a toxic effect. After the head surfaces, including the surface of the tape cleaner, have been carefully swabbed, they should be dried with a dry, clean, lint-free cloth.
- Clean the head guides and head guide blocks with head cleaner. The guide blocks are immediately in back of the guides. Dry all parts with a clean, lint-free cloth.
- Replace head cover by aligning the holes in the cover with the mounting pins on the transport and press firmly into place.

Capstan cleaning should be performed *after every eight hours* of use:

- Moisten a cloth with head cleaning solution, again being careful not to get it on the skin.
- Rotate the capstan slowly with one hand, without touching the rubber surface. At the same time, clean the surface of the capstan with the moistened cloth.
- Make a visual inspection of the capstan surface for abrasion or polish. If defects are observed, contact your service representative.

Additional cleaning should be performed at longer intervals: *Every four months* the entire surface of the tape drive should be cleaned with solvent, making sure that accumulations of dust around the hold-down knobs and in the head area are removed. Head covers should be removed and cleaned on the inside and outside, making sure that all deposits of dust and other possible tape contaminants are removed.

Any periodic maintenance functions beyond those described here should be performed by a service representative.

GENERAL CLEANING

Keep the immediate area clear of stacked papers, books, and other items that might interfere with free air circulation.

Wipe up or brush off dust, lint, and smudges whenever they become noticeable, being careful not to wipe or brush dust into exposed internal areas of the unit. Use a soft clean dust cloth or a commercial grade lint-free tissue, and be careful not to scratch surfaces by hard rubbing.

For stubborn accumulations, dampen the cloth or tissue slightly, but only with plain water or a cleaning fluid suitable (safe) for use on plastic and painted surfaces, such as one of the commercially available antistatic cleaning fluids. The cloth or tissue should not be wet, just damp, so that it will pick up dust or dirt readily.

The occasional light cleaning described above will not always prevent the gradual accumulation of a coating of varnish-like dirt, and a more thorough cleaning will usually be necessary about once a month. Wipe all surfaces with the antistatic cleaning fluid and use a succession of soft cloths or lint-free tissues. As each cloth or tissue becomes dirty, discard it and continue with a clean one. Use enough fluid to moisten each cloth or tissue thoroughly so that very little wiping pressure will be needed, but not enough to allow dripping under the wiping pressure. After cleaning each surface, wipe off the fluid and dissolved dirt with a dry cloth or tissue.

Pay particular attention to plexiglas surfaces, where any residual dirt film will easily be visible.

On this page, enter the name of your CUSTOMER SERVICE REPRESENTATIVE (CSR) or SORBUS SERVICE REPRESENTATIVE who will supply the information needed:

For Hardware Errors - Machine Errors - Computer Errors, call: _____

Name of Service Representative: _____

Daytime Phone (9-5): () _____ Extension: _____

() _____ Extension: _____

Emergency Phone (other) () _____ Extension: _____

() _____ Extension: _____

Special Instructions:

Your Service Representative may need to know the serial numbers of your equipment. These are found on the back of the video display terminal, central processing unit, magnetic tape cartridge drive unit, and printer. Please record the numbers below for easy reference.

Video display terminal _____

Central processing unit _____

Magnetic tape cartridge drive unit _____

Printer _____
